



DESIGN
MANUAL

SHIBATA**FENDER****TEAM**

▶ | on the safe side

FENDER DESIGN

WELCOME TO THE SHIBATAFENDERTEAM DESIGN MANUAL

Fenders are the interface between ship and berth. They are first and foremost a safety barrier to protect people, ships and structures. Most fender systems use elastomeric (rubber) units, air or special foams which act as springs to absorb the ship's kinetic energy. The force applied by the berthing ship compresses the spring, absorbing energy and transferring these forces into other parts of the fender system – panels, anchors and chains – then into the supporting structures via a defined load path.

Good fender design encompasses many disciplines. Textbook knowledge must complement the experience of real world shipping operations and berthing manoeuvres. Most design codes and standards require the designer to have a good working knowledge of the subject. ShibataFenderTeam meets this challenge with over 50 years of diverse experience in all aspects of fender design and applications.

This guide is intended as a concise resource to assist designers and specifiers to identify the key input criteria, to calculate berthing energies and to select the optimal fender types. ShibataFenderTeam specialists are always available to support in this process and provide advice on details and specifications.

EXCEPTIONS This manual is applicable to most conventional and commercial ships. Please speak to ShibataFenderTeam about special applications and requirements for unusual ships such as catamarans, navy ships, offshore rigs and operations.

SHIBATAFENDERTEAM

ShibataFenderTeam is headquartered in Germany with regional hubs in the USA, Europe, Middle East, Asia and Australia. Our network of well-established local representatives spans all six continents.

Our Japanese mother company, Shibata Industrial Co. Ltd., has developed and manufactured a vast range of engineered rubber products since 1923, and has been a pioneer in fender design and manufacturing for over 50 years. ShibataFenderTeam owns and operates testing and manufacturing facilities in Japan, Malaysia and Germany, where we produce:

- ▶ Many special products for marine applications which exploit our knowledge of rubber, steel, Polyurethane and Polyethylene
- ▶ Extruded and Molded Rubber Fender units up to single weights of 18.5 t
- ▶ Pneumatic Fenders with diameters up to 3.3 m and 9.0 m length
- ▶ Foam Fenders with diameters up to 4.5 m and 10 m length
- ▶ HD-PE Sliding Fenders up to 300 mm x 300 mm cross-section and 6 m length
- ▶ Steel constructions with single unit weights up to 30 t
- ▶ Buoys for various applications up to 4.5 m diameter

In addition to this outstanding expertise, our team of partners, employees, reputable and approved suppliers have decades of specialist knowledge in the design of safety critical fender systems, protecting people, ships and port infrastructure.

ShibataFenderTeam combines these resources and skills whenever for every state-of-the-art fender system. Our in-house manufacturing facilities and high-quality products at competitive prices have earned ShibataFenderTeam a reputation as a dependable partner in the international port, harbor and waterways markets.

PART 1

BERTHING ENERGY CALCULATION

Symbols & Information Sources	04
Design Process	05
Ships.....	06
Ship Dimensions	07
Ship Terminology	08
Tankers	09
Bulk Carriers.....	10
Gas Carriers.....	11
Container Ships	12
General Cargo (Freighter), RoRo & Ferries	13
Car Carriers, Cruise Ships & Fast Ferries.....	14
Ship Limits	15
Ship Loads.....	16
Ship Approach	17
Added Mass Coefficient (C_M).....	18
Eccentricity Coefficient (C_E)	19
Berth Configuration (C_C) & Softness Coefficient (C_S).....	20
Berthing Speeds	21
Berthing Energy.....	22

PART 2

FENDER SELECTION GUIDE.....23

The full fender selection process, materials, testing and related information is covered in PART 2.

SYMBOLS & SOURCES

Symbol	Description	Units
B	Beam (breadth) of vessel, excluding belting	m
C	Typical clearance between ship hull and face of structure	m
C _B	Block coefficient of the vessel's hull	
C _C	Berth configuration coefficient	
C _E	Eccentricity coefficient	
C _M	Hydrodynamic (added) mass coefficient	
C _S	Softness coefficient	
D	Actual draft of ship	m
D _B	Ballast draft of ship	m
D _L	Laden or summer draft of ship	m
D _S	Scantling (maximum) draft of ship	m
D _U	Unladen draft	m
E _A	Abnormal kinetic berthing energy of ship	kNm (kJ)
E _F	Fender energy (corrected for angle, temperature etc.)	kNm (kJ)
E _N	Normal kinetic berthing energy of ship	kNm (kJ)
E _{RPD}	Fender energy (at rated performance datum)	kNm (kJ)
E _{LET}	Fender energy at low end tolerance (at minimum manufacturing tolerance)	kNm (kJ)
F	Impact force applied to fender face or panel by ship hull	kN
F _B	Ballast freeboard of ship to deck level	m
F _L	Laden or summer freeboard of ship to deck level	m
F _S	Scantling (minimum) freeboard of ship to deck level	m
H	Height of compressible fender excluding panel etc.	m
H _M	Moulded depth	m
HP	Hull pressure	kN/m ² (kPa)
K	Radius of gyration of ship	m
K _C	Under keel clearance to seabed	m
L _L	Overall length of largest ship using the berth	m
L _{OA}	Overall length of ship	m
L _{BP}	Length of ship between perpendiculars	m
L _S	Overall length of smallest ship using the berth	m
L _{WL}	Length of ship hull at waterline at laden draft	m
M _B	Displacement of ship in ballast condition	t
M _D	Displacement of ship	t
P	Spacing between fenders	m
R	Distance from point of impact to ship's center of mass	m
R _B	Bow radius	m
R _F	Fender reaction (corrected for angle, temperature etc.)	kN
R _{RPD}	Fender reaction (at rated performance datum)	kN
R _{HET}	Fender reaction at high end tolerance (at maximum manufacturing tolerance)	kN
T	Shear force	kN
v	Velocity of ship	m/s
v _B	Velocity of ship perpendicular to berthing line	m/s
v _L	Velocity of ship parallel to berthing line	m/s
x	Distance from bow to parallel mid-body (end of bow radius)	m
α	Berthing angle (ship center line to berthing line)	deg.
β	Bow flare angle (vertical hull angle to fender panel face)	deg.
γ	Velocity vector angle (between R and V _B)	deg.
Δ	Deflection of compressible fender	m
θ	Horizontal angle with fender (allowing for bow radius)	deg.
η	Factor of safety for abnormal berthing energy	
η _c	Factor of safety for chains	
μ	Friction coefficient	
ρ _{SW}	Seawater density	t/m ³

Codes & Standards

Code of Practice for Design of Fendering and Mooring Systems: BS 6349: Part 4 (2014)

PIANC WG33 Guidelines for the Design of Fenders (2002)

Recommendations of the Committee for Waterfront Structures, Harbours and Waterways (EAU 2004)

PIANC Report of the International Commission for Improving the Design of Fender Systems: Supplement to Bulletin No.45 (1984)

Actions in the Design of Maritime and Harbour Works: ROM 2.0-11 (2012)

Recommendations for the Design of the Maritime Configuration of Ports, Approach Channels and Harbour Basins: ROM 3.1-99 (1999)

Dock Fenders – Rosa 2000 Edition No.1

Engineering and Design of Military Ports: Unified Facilities Criteria UFC 4-159-02 (2004)

Design of Piers And Wharves: Unified Facilities Criteria UFC 4-152-01 (2005)

Guidelines for the Design of Maritime Structures – Australia: AS4997 (2005)

Technical Standards and Commentaries for Port and Harbour Facilities in Japan (2009)

Approach Channels – A Guide to Design: PIANC Supplement to Bulletin No.95 (1997)

Port Designer's Handbook – Recommendations and Guidelines: Carl Thoresen (2003) ISBN 9780727732886

Planning and Design of Ports and Marine Terminals: Edited by Hans Agerschou – 2nd Edition (2004) ISBN 0727732242

Significant Ships: Royal Institute of Naval Architects (1992-2010) www.rina.org.uk

Standard Test Method for Determining and Reporting the Berthing Energy and Reaction of Marine Fenders: ASTM F2192-05 (2005)

Standard Classification System for Rubber Products In Automotive Applications: ASTM D2000 (2012)

DESIGN PROCESS

Fender design brings together many skills and disciplines. The engineer must consider all factors that will determine the fender size, details of accessories and how reliably it will function in extreme marine conditions.

The optimum fender design will result in a safe, low-maintenance and long lasting structure which benefits port efficiency and provides lowest life cycle costs. An important consideration is who takes responsibility for purchasing the fender system. A port will buy the system to suit their need, but a contractor will select the most economic fender that meets the specifications. This means the properties and performance of the fender must be chosen very carefully or the consequences can be costly for the operator.

SHIPS



- ▶ Classes
- ▶ Laden or ballast
- ▶ Flares
- ▶ Beltings
- ▶ Hull pressure

STRUCTURE



- ▶ Service life
- ▶ Loads
- ▶ Construction
- ▶ Connection
- ▶ Frequency

APPROACH



- ▶ Wharf or dolphin
- ▶ RoRo ramp
- ▶ Lock or dry lock
- ▶ Tug assistance

LOCATION



- ▶ Exposure
- ▶ Tidal range
- ▶ Currents & waves
- ▶ Passing ships
- ▶ Accessibility

ENVIRONMENT



- ▶ Temperatures
- ▶ Corrosivity
- ▶ Ice flows
- ▶ Seismic events
- ▶ Ozone & UV

MATERIALS



- ▶ Durability
- ▶ Testing
- ▶ Coatings
- ▶ Galling
- ▶ Capital costs
- ▶ Maintenance

STRUCTURES

Fenders are mounted onto berth structures – sometimes newly built, sometimes upgraded or refurbished. Structures fall into two main categories: mass structures that can withstand high reaction forces from fenders and load critical structures which can resist limited fender forces.

Mass structures are usually made of sheet pile, concrete block or caisson construction. These are all very solid but can be impractical to build in deep water and exposed locations. Consequently these are most often located within harbours and waterways. Load critical structures include suspended deck designs and monopiles where fender and mooring loads are primary design forces. Berths may be further divided into continuous wharves or quays, and individual (non-continuous) structures usually known as dolphins. Some dolphins are rigid designs, with inclined piles or other bracings. Monopiles are a special category of dolphin structure.

MASS STRUCTURES

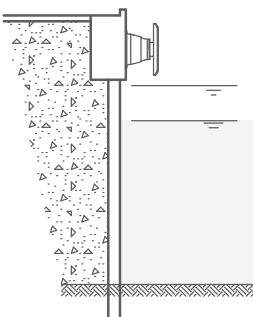

- ▶ Can resist large fender forces
- ▶ Easy fitting to concrete cope
- ▶ Sheet pile connection needs careful detailing
- ▶ Avoid fixings that cross expansion joints

LOAD CRITICAL STRUCTURES

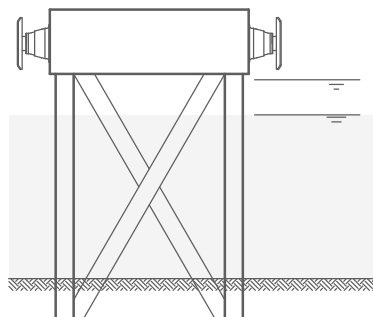

- ▶ Load sensitive structure
- ▶ Limited 'footprint' area for fixing fenders and chains
- ▶ Deck usually concrete but sometimes steel

DOLPHINS & MONOPILES

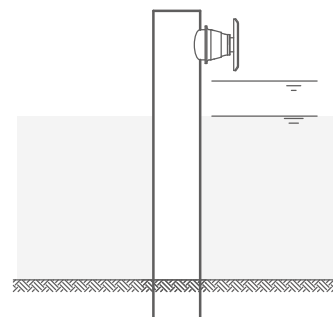

- ▶ Load sensitive structure
- ▶ Monopile contributes to total energy absorption
- ▶ Limited 'footprint' area for fixing fenders and chains

SHIPS

Ships come in every imaginable shape and size. Berths should accommodate the largest design ships, but they must also cater for small and intermediate ships, particularly if these represent the majority of berthings. On many export berths the ships might arrive “in ballast” condition with a reduced draft and displacement. If this is standard practice, the design should consider fenders for this situation but also consider that ships might need to return to the berth fully laden.

The features of a ship will affect the fender selection and design. For example, cruise ship operators do not like black marks caused by contacting cylindrical rubber fenders. Container ships and car carriers may have large bow flares so a fender must articulate to match the angle. Many ships have beltings (sometimes called ‘belts’, rubrails or ‘strakes’) which may sit on or catch under fender panels, so larger bevels or chamfers may be needed. Double hulled tankers, gas carriers and other soft-hulled ships can only resist limited contact pressures which means that a large contact area of fender panel is needed.

The hull form or curvature of the ship is important. The bow radius influences where a ship contacts the fender relative to its center of mass. It also influences the number of fenders compressed depending on their spacing. Bow flares may push the upper edges of the fender closer to the structure so upper edges of the panel, chain brackets etc. need to be checked for clearance.

Below are the most common classes of commercial ships and the main features a designer should consider:

TANKERS



- ▶ Hazardous cargo
- ▶ Large change in draft
- ▶ Low hull pressures
- ▶ Tug assistance is standard
- ▶ Small tankers can have beltings
- ▶ Berthing is often at exposed sites
- ▶ Many terminals use laser DAS*

BULK

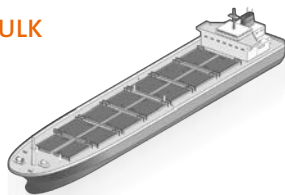

- ▶ Some vessels are multi-purpose (OBO – oil/bulk/ore)
- ▶ Cargoes might be hazardous
- ▶ Large change in draft
- ▶ Low hull pressures
- ▶ Tug assistance is standard
- ▶ Berthing is often at exposed sites

GAS

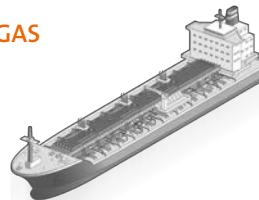

- ▶ Very hazardous cargo
- ▶ Single class of ships on dedicated terminals
- ▶ Low hull pressures
- ▶ Tug assisted berthing is standard
- ▶ Small tankers can have beltings
- ▶ Berthing is often at exposed sites
- ▶ Many terminals have laser DAS*

CONTAINER

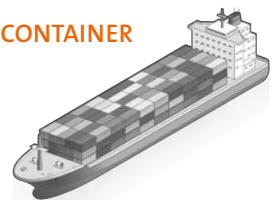

- ▶ Large bow flares pose risk to container cranes
- ▶ Large beam limits fender size
- ▶ Low hull pressures
- ▶ Tug assisted berthing is standard except on feeder routes
- ▶ Small ships can have beltings
- ▶ Stable fenders help productivity

RORO

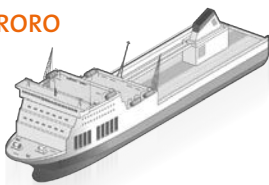

- ▶ Passenger safety is critical
- ▶ Many ship shapes and sizes
- ▶ Berthing without pilots
- ▶ Side and stern berthing
- ▶ Most ships have beltings
- ▶ Fast turnaround times and intensive berth use
- ▶ Tug assistance rarely used

FREIGHTER



- ▶ Many ship shapes and sizes
- ▶ Smaller fenders preferred to reduce crane outreach
- ▶ Larger ships may use tugs
- ▶ Can occupy berths for long periods
- ▶ Large change in draft
- ▶ Many ship sizes use a berth
- ▶ Tug assistance for larger ships only

CAR CARRIERS

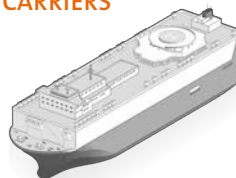

- ▶ Manoeuvring difficult at low speeds due to high freeboard
- ▶ Long flat side with large bow flare
- ▶ May have beltings and side doors
- ▶ Tug assisted berthing is common
- ▶ Side and stern berthing

CRUISE

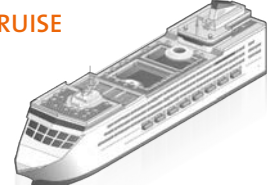

- ▶ Passenger safety is critical
- ▶ Small changes in draft
- ▶ Ship sizes getting larger for many ports
- ▶ Large bow flares common
- ▶ Low hull pressure unless belted
- ▶ Non-marking fenders preferred
- ▶ Many ship sizes use a berth

*Docking Aid Systems

SHIP DIMENSIONS

Designers should consider the dimensions of a range of ships that will use the berth and fenders. The most important characteristics to define are described below:

Length overall	L_{OA}	Maximum length of ship which defines size of lock or dry dock needed. Sometimes referred to as "L".
Length between perpendiculars	L_{BP}	Length between the rudder pivot and the bow intersection with waterline. This is not the same as length at waterline although the two are often confused.
Beam (or breadth)	B	The width of the ship, usually at the center of the ship. Beam dimensions from some sources may include beltings but this is not relevant to berthing energy calculations.
Laden draft	D_L	Laden draft is usually the maximum summer draft for good operating conditions. Ships will operate at this draft or less depending on amount of cargo carried.
Ballast draft	D_B	The minimum sailing draft when ship is unloaded and sailing in ballast condition. Usually considered only for tankers, bulk carriers, freighter and container ships. Ballast draft for tankers, bulk carriers and container ships is estimated as $D_B \approx 2 + 0.02 L_{OA}$.
Scantling draft (not shown)	D_S	The maximum permitted draft of a ship. Rarely used for fender design.
Laden freeboard	F_L	The freeboard at midships corresponding to laden draft (D_L).
Ballast freeboard	F_B	The freeboard at midships corresponding to ballast draft (D_B).
Under keel clearance	K_C	The depth of water under the ship's hull (keel). The effect of ballast or laden displacement, high or low tide should be considered to determine worst design cases.
Bow radius	R_B	The notional radius of the ship bow on a horizontal plane approximately coinciding with the fender level. The radius is often taken as a constant for fender design but in practice can vary according to ship draft.
Distance bow to impact	x	Often not well defined as may vary with ship profile, berthing angle etc. The distance is commonly referred to as quarter point ($x = 0.25 L_{OA}$), fifth point ($x = 0.2 L_{OA}$) etc. measured from the bow (or stern). See 'Eccentricity coefficient' for more details.
Impact to center of mass	R	This dimension is used when determining the Eccentricity coefficient (C_E). By convention center of mass is assumed to be at midships ($L_{OA}/2$) but may actually be 5–10 % aft of midships for oil, bulk and cargo ships in ballast and/or trimmed by stern.

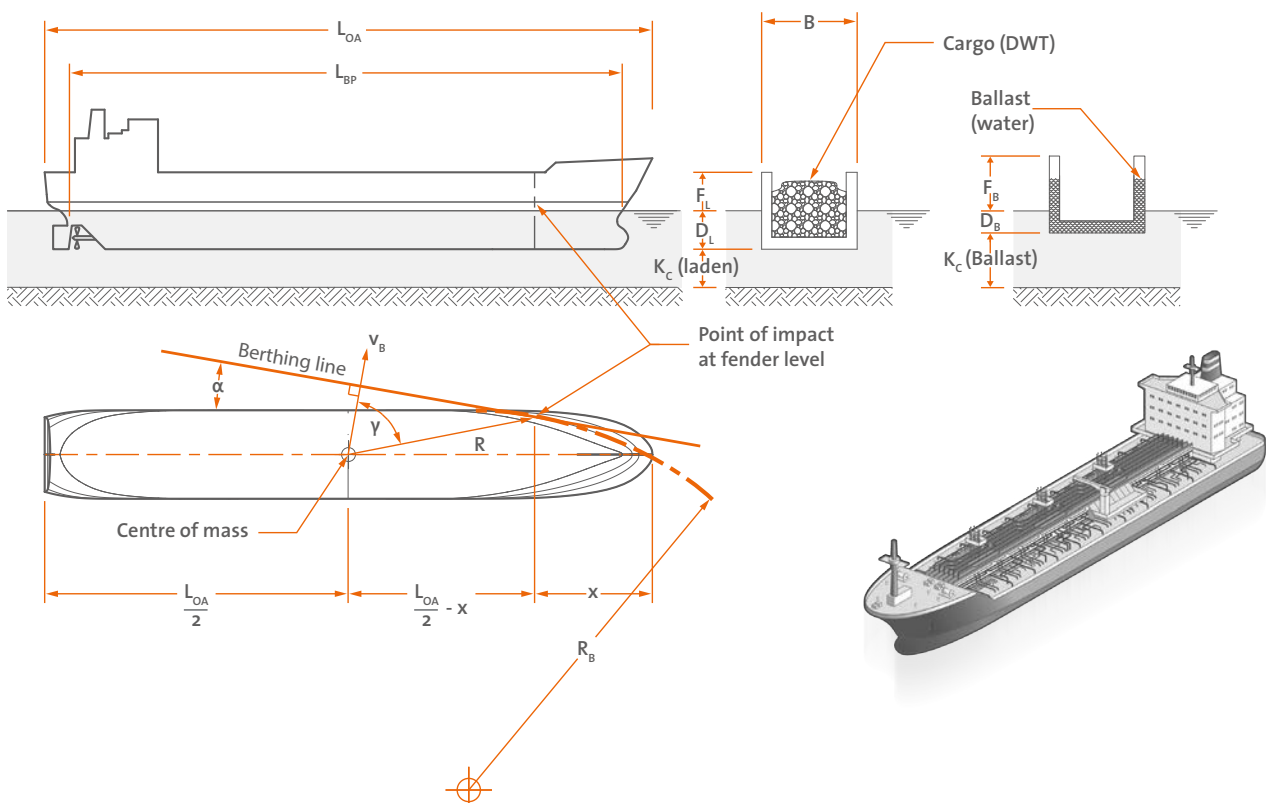

SHIP TERMINOLOGY

Displacement M_D	The weight of the ship, the same as the weight of water displaced by the hull when loaded to the stated draft.
Deadweight DWT	The weight a ship is designed to safely carry, including cargo, fuel, fresh water and ballast water.
Lightweight LWT	The weight of a bare ship excluding cargo, fuel etc.
Gross Registered Tonnage GRT	An obsolete measure of the ship's internal volume where: 1 GRT = 100 ft ³ = 2.83 m ³ GRT is not related to displacement and is irrelevant to fender design.
Gross Tonnage GT	A unitless index of the ship's internal volume used by the IMO. Sometimes (and wrongly) called GRT which it replaced in 1982. GT is not related to displacement and is irrelevant to fender design.
Twenty-foot Equivalent Units TEU	The size of a single, standard 20 foot long container, used as an indication of container ship size or capacity.

SHIP MOTIONS

As well as their berthing speed to the fenders, ships may have other motions caused by wind, waves and currents which cause angular or shear movements of the fender during initial contact and while moored. In particular:

- Passing ships:** Surge, sway and yaw
- Wind:** Roll, sway and yaw
- Tide, currents:** Surge and heave
- Waves, swell:** Surge and pitch

Designers should consider these motions and the effect they have on fenders such as shear forces, fatigue, abrasion and vibration effects on fixings.

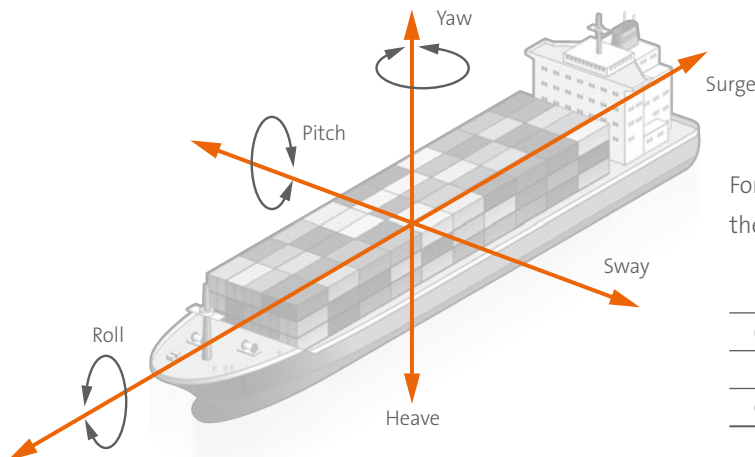

BLOCK COEFFICIENT (C_B)

The Block Coefficient (C_B) is the ratio of the actual volume of the hull to the 'box' volume of the hull usually expressed as:

$$C_B = \frac{M_D}{L_{BP} \times D_L \times B \times \rho_{SW}}$$

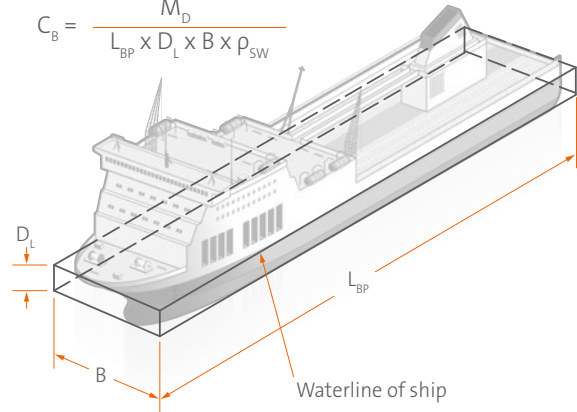

If known, C_B can be used to estimate displacement:

$$M_D = C_B \times L_{BP} \times D_L \times B \times \rho_{SW}$$

Design codes and standards suggest some typical ranges of block coefficient for various ship classes:

Ship Class	ROM 3.1-99	BS 6349	PIANC 2002
Tankers	0.72–0.85	0.72–0.85	0.85
Bulk (OBO)	0.78–0.87	0.72–0.85	0.72–0.85
Gas	0.68–0.54	—	—
Container	0.63–0.71	0.65–0.70	0.60–0.80
RoRo	0.57–0.80	0.65–0.70	0.70–0.80
Freighter	0.56–0.77	—	0.72–0.85
Car Carrier	0.56–0.66	—	—
Cruise/Ferry	0.57–0.68	0.50–0.70	—
Fast Monohull	0.45–0.49	—	—
Catamaran*	0.43–0.44	—	—

* Beam (B) is the total of the two individual hulls

For load conditions other than fully laden (i.e. $D < D_L$) the Block Coefficient can be estimated:

Hull form	Actual draft, D	C_B (at $D < D_L$)
C_B (at D_L) ≥ 0.75	$D_B < D < D_L$	Constant
	$0.6 D_L < D < D_L$	Constant
C_B (at D_L) < 0.75	$D_B < D < 0.6 D_L$	$0.9 \times C_B$ (at D_L)

TANKERS



DWT	M _D [t]	L _{OA} [m]	L _{BP} [m]	B [m]	H _M [m]	D _L [m]	D _B [m]	C _B
500,000	590,000	415	392	73.0	30.5	24.0	10.3	0.838
441,585	528,460*	380	359	68.0	28.9	24.5	9.6	0.862
400,000	475,000	380	358	68.0	29.2	23.0	9.6	0.828
350,000	420,000	365	345	65.5	28.0	22.0	9.3	0.824
300,000	365,000	350	330	63.0	27.0	21.0	9.0	0.816
275,000	335,000	340	321	61.0	26.3	20.5	8.8	0.814
250,000	305,000	330	312	59.0	25.5	19.9	8.6	0.812
225,000	277,000	320	303	57.0	24.8	19.3	8.4	0.811
200,000	246,000	310	294	55.0	24.0	18.5	8.2	0.802
175,000	217,000	300	285	52.5	23.0	17.7	8.0	0.799
150,000	186,000	285	270	49.5	22.0	16.9	7.7	0.803
125,000	156,000	270	255	46.5	21.0	16.0	7.4	0.802
100,000	125,000	250	236	43.0	19.8	15.1	7.0	0.796
80,000	102,000	235	223	40.0	18.7	14.0	6.7	0.797
70,000	90,000	225	213	38.0	18.2	13.5	6.5	0.804
60,000	78,000	217	206	36.0	17.0	13.0	6.3	0.789
50,000	66,000	210	200	32.2	16.4	12.6	6.2	0.794
40,000	54,000	200	190	30.0	15.4	11.8	6.0	0.783
30,000	42,000	188	178	28.0	14.2	10.8	5.8	0.761
20,000	29,000	174	165	24.5	12.6	9.8	5.5	0.714
10,000	15,000	145	137	19.0	10.0	7.8	4.9	0.721
5,000	8,000	110	104	15.0	8.6	7.0	4.2	0.715
3,000	4,900	90	85	13.0	7.2	6.0	3.8	0.721

* V-plus class carriers (world's largest in current service - TI Europa & TI Oceana). Ballast draft assumes Marpol Rules

Type	Dimensions	Ship size
Small		≤ 10,000 DWT
Handysize	D _L ≤ 10 m	10,000–30,000 DWT
Handymax	L _{OA} ≤ 180 m	30,000–55,000 DWT
Panamax	B ≤ 32.3 m L _{OA} ≤ 289.6 m D _L ≤ 12.04 m	60,000–75,000 DWT
Aframax	41 ≤ B ≤ 44 m	80,000–120,000 DWT
Suezmax	D _L ≤ 21.3 m B ≤ 70 m L _{OA} ≤ 500 m	125,000–170,000 DWT
VLCC (Very Large Crude Carrier)	L _{OA} ≤ 300 m	250,000–320,000 DWT
ULCC (Ultra Large Crude Carrier)		≥ 350,000 DWT

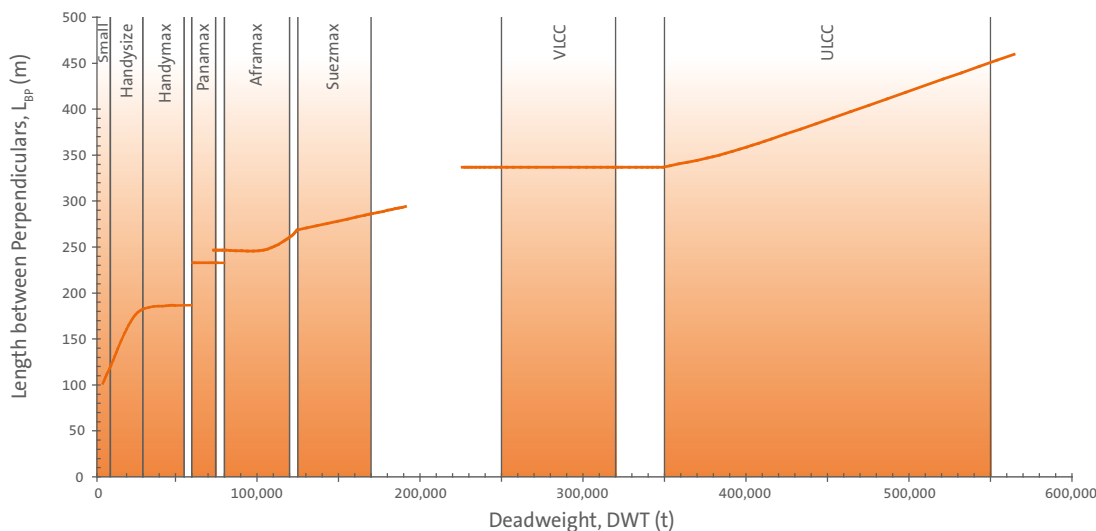
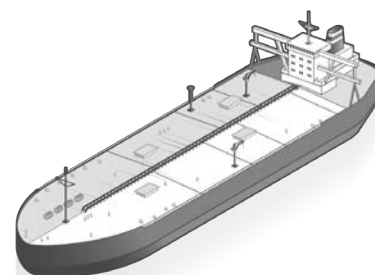

BULK CARRIERS



DWT	M_D [t]	L_{OA} [m]	L_{BP} [m]	B [m]	H_M [m]	D_L [m]	D_B [m]	C_B
402,347	454,000	362	350	65.0	30.4	23.0	9.2	0.846
400,000	464,000	375	356	62.5	30.6	24.0	9.5	0.848
350,000	406,000	362	344	59.0	29.3	23.0	9.2	0.849
300,000	350,000	350	333	56.0	28.1	21.8	9.0	0.840
250,000	292,000	335	318	52.5	26.5	20.5	8.7	0.832
200,000	236,000	315	300	48.5	25.0	19.0	8.3	0.833
150,000	179,000	290	276	44.0	23.3	17.5	7.8	0.822
125,000	150,000	275	262	41.5	22.1	16.5	7.5	0.816
100,000	121,000	255	242	39.0	20.8	15.3	7.1	0.818
80,000	98,000	240	228	36.5	19.4	14.0	6.8	0.821
60,000	74,000	220	210	33.5	18.2	12.8	6.4	0.802
40,000	50,000	195	185	29.0	16.3	11.5	5.9	0.791
20,000	26,000	160	152	23.5	12.6	9.3	5.2	0.764
10,000	13,000	130	124	18.0	10.0	7.5	4.6	0.758

Ballast draft assumes Marpol Rules.

Type	Dimensions	Ship size
Small	$L_{OA} \leq 115$ m	$\leq 10,000$ DWT
Handysize	$D_L \leq 10$ m	10,000–35,000 DWT
Handymax	$L_{OA} \leq 190$ m	35,000–55,000 DWT
Panamax	$B \leq 32.3$ m $L_{OA} \leq 289.6$ m $D_L \leq 12.04$ m	60,000–80,000 DWT
Capesize	$41 \leq B \leq 44$ m	80,000–200,000 DWT 90,000–180,000 DWT
Chinamax		$\leq 300,000$ DWT
VLBC (Very Large Bulk Carrier)	$L_{OA} \geq 300$ m	$\geq 200,000$ DWT

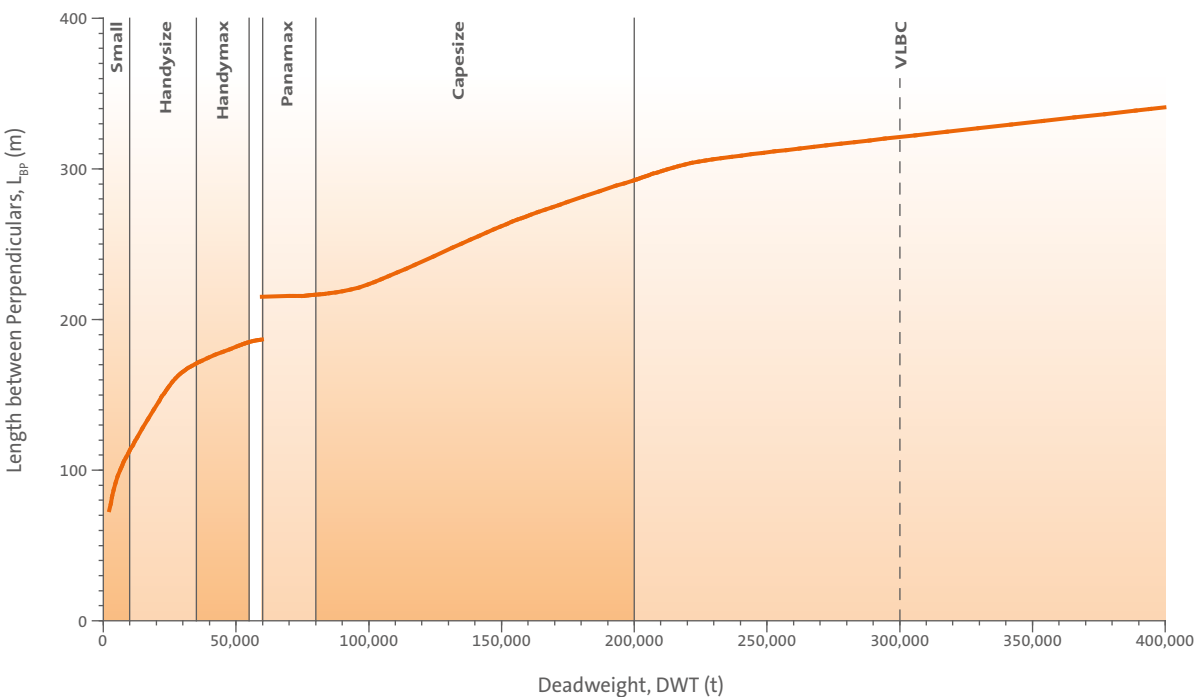
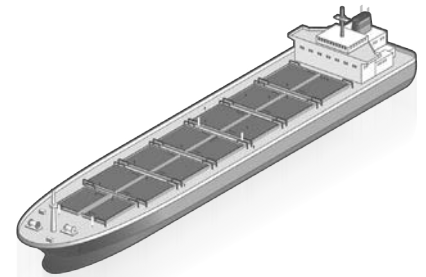

GAS CARRIERS

Capacity [m ³]	DWT	M _D [t]	L _{OA} [m]	L _{BP} [m]	B [m]	H _M [m]	D _L [m]	D _B [m]	C _B
LNG CARRIER – PRISMATIC									
266,000	125,000*	175,000	345.0	333.0	53.8	27.6	12.0	8.9	0.794
210,000	97,000**	141,000	315.0	303.0	50.0	26.2	12.0	8.3	0.757
177,000	90,000	120,000	298.0	285.0	46.0	26.2	11.8	8.0	0.757
140,000	80,000	100,000	280.0	268.8	43.4	24.5	11.4	7.6	0.734
75,000	52,000	58,000	247.3	231.0	34.8	20.6	9.5	6.9	0.741
40,000	27,000	40,000	207.8	196.0	29.3	17.3	9.2	6.2	0.739
LNG CARRIER – SPHERICAL, MOSS									
145,000	75,000	117,000	288.0	274.0	49.0	24.7	11.5	7.8	0.739
125,000	58,000	99,000	274.0	262.0	42.0	23.7	11.3	7.5	0.777
90,000	51,000	71,000	249.5	237.0	40.0	21.7	10.6	7.0	0.689
LPG CARRIER									
131,000	60,000	95,000	265.0	245.0	42.2	23.7	13.5	7.3	0.664
109,000	50,000	80,000	248.0	238.0	39.0	23.0	12.9	7.0	0.652
88,000	40,000	65,000	240.0	230.0	35.2	20.8	12.3	6.8	0.637
66,000	30,000	49,000	226.0	216.0	32.4	19.9	11.2	6.5	0.610
44,000	20,000	33,000	207.0	197.0	26.8	18.4	10.6	6.1	0.575
22,000	10,000	17,000	160.0	152.0	21.1	15.2	9.3	5.2	0.556
11,000	5,000	8,800	134.0	126.0	16.0	12.5	8.1	4.7	0.526
7,000	3,000	5,500	116.0	110.0	13.3	10.1	7.0	4.3	0.524
METHANE CARRIER									
131,000	60,000	88,000	290.0	257.0	44.5	26.1	11.3	7.8	0.664
88,000	40,000	59,000	252.0	237.0	38.2	22.3	10.5	7.0	0.606
44,000	20,000	31,000	209.0	199.0	30.0	17.8	9.7	6.2	0.522

*Q-max and **Q-flex class gas carriers. Ballast draft assumes Marpol Rules.

Type	Dimensions	Ship size
Small	L _{OA} ≤ 250 m B ≤ 40 m	≤ 90,000 m ³
Small Conventional	L _{OA} 270–298 m B 41–49 m	120,000–150,000 m ³
Large Conventional	L _{OA} 285–295 m B ≤ 43–46 m D _L ≤ 12 m	150,000–180,000 m ³
Q-flex	L _{OA} ≈ 315 m B ≈ 50 m D _L ≤ 12 m	200,000–220,000 m ³
Q-max	L _{OA} ≈ 345 m B ≈ 53–55 m D _L ≤ 12 m	≥ 260,000 m ³
Med-max		Approx 75,000 m ³
Atlantic-max		Approx 165,000 m ³

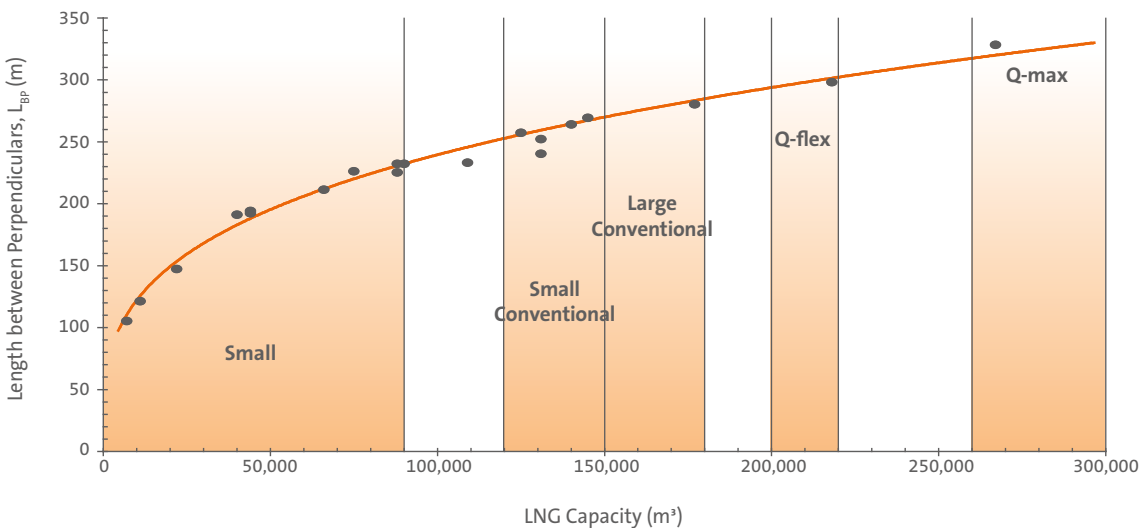
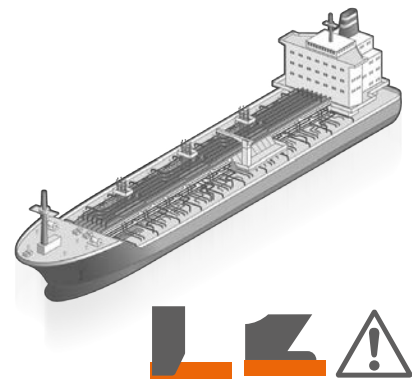

CONTAINER SHIPS



TEU	DWT	M _D [t]	L _{OA} [m]	L _{BP} [m]	B [m]	H _M [m]	D _L [m]	D _B [m]	C _B
20,568	210,019**	270,224	399	380	58.6	33.2	16.0	10.7	0.740
20,170	192,672***	271,880	400	381	58.6	32.8	16.0	10.7	0.743
18,340	196,000**	272,089	399	380	59.0	33.2	16.0	10.7	0.741
18,000	195,000**	262,566	420	395	56.4	26.7	15.0	9.9	0.767
15,500	156,907*	222,627	397	375	56.4	25.3	14.0	9.4	0.734
14,000	157,000	190,828	366	350	48.4	24.8	15.0	9.0	0.733
12,500	143,000	171,745	366	350	48.4	24.5	13.5	9.0	0.733
10,000	101,000	145,535	349	334	45.6	23.6	13.0	8.7	0.717
8,000	81,000	120,894	323	308	42.8	22.7	13.0	8.2	0.688
6,500	67,000	100,893	300	286	40.0	21.7	13.0	7.7	0.662
5,500	58,000	85,565	276	263	40.0	20.9	12.5	7.3	0.635
5,100	54,000	74,399	294	283	32.2	20.4	12.0	7.7	0.664
4,500	48,600	70,545	286	271	32.2	19.8	12.0	7.4	0.657
4,000	43,200	65,006	269	256	32.2	19.0	11.8	7.1	0.652
3,500	38,100	54,885	246	232	32.2	18.2	11.3	6.6	0.634
2,800	30,800	42,389	211	196	32.2	17.0	10.7	5.9	0.612
2,800	30,800	43,166	222	210	30.0	17.0	10.6	6.2	0.631
2,500	27,700	37,879	209	197	30.0	16.4	10.0	5.9	0.625
2,000	22,400	32,208	202	190	28.0	15.3	9.2	5.8	0.642
1,600	18,200	26,762	182	170	28.0	14.4	8.6	5.4	0.638
1,200	13,800	19,219	160	149	25.0	13.4	8.0	5.0	0.629
1,000	11,600	15,719	150	140	23.0	12.9	7.6	4.8	0.627
800	9,300	13,702	140	130	21.8	12.3	7.4	4.6	0.637
600	7,000	10,390	122	115	19.8	11.7	7.0	4.3	0.636
400	4,800	7,472	107	100	17.2	11.1	6.5	4.0	0.652

Capacities and dimensions are compiled from multiple sources including ROM, MAN and PIANC. Ballast draft assumes Marpol Rules.
 *E class **Triple-E class ***Pegasus class

Type	Dimensions	Ship size
Small	B ≤ 23.0 m (approx.)	≤ 1,000 TEU
Feeder	23.0 m < B ≤ 30.0 m	1,000–2,800 TEU
Panamax	B ≤ 32.3 m D _L ≤ 12.04 m L _{OA} ≤ 294.1 m	2,800–5,100 TEU
Post-Panamax (existing)	39.8 m ≤ B ≤ 45.6 m	5,500–10,000 TEU
New Panamax	B ≤ 49.0 m D _L ≤ 15.2 m L _{OA} ≤ 365.8 m	12,000–14,000 TEU
ULCS (Ultra Large Container Ship)	B > 49.0 m	> 14,500 TEU

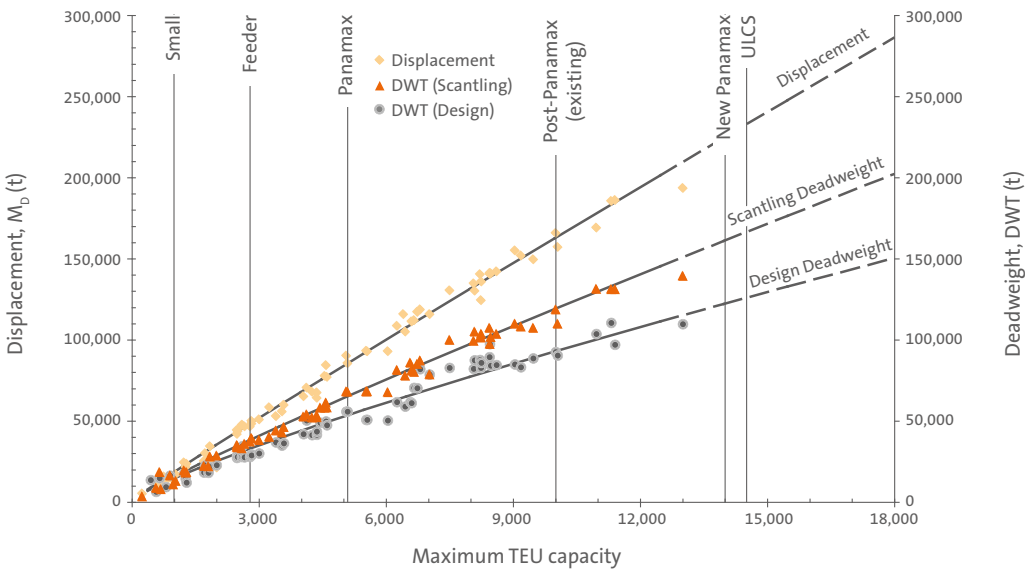
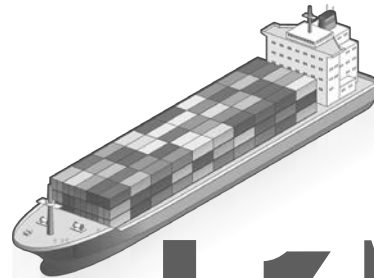

GENERAL CARGO (FREIGHTER)



DWT	M _D [t]	L _{OA} [m]	L _{BP} [m]	B [m]	H _M [m]	D _L [m]	D _B [m]	C _B
40,000	54,500	209	199	30.0	18	12.5	6.2	0.713
35,000	48,000	199	189	28.9	17	12.0	6.0	0.714
30,000	41,000	188	179	27.7	16	11.3	5.8	0.714
25,000	34,500	178	169	26.4	15.4	10.7	5.6	0.705
20,000	28,000	166	158	24.8	13.8	10.0	5.3	0.697
15,000	21,500	152	145	22.6	12.8	9.2	5.0	0.696
10,000	14,500	133	127	19.8	11.2	8.0	4.7	0.703
5,000	7,500	105	100	15.8	8.5	6.4	4.1	0.724
2,500	4,000	85	80	13.0	6.8	5.0	3.7	0.750

Ballast draft assumes Marpol rules.



Freighter

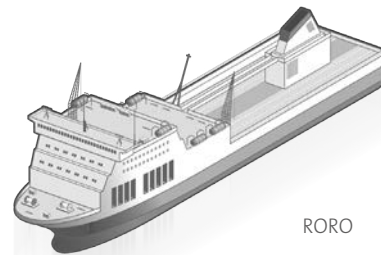

RORO



RORO & FERRIES



DWT	GT	M _D [t]	L _{OA} [m]	L _{BP} [m]	B [m]	H _M [m]	D _L [m]	C _B
FREIGHT RORO								
–	50,000	87,500	287	273	32.2	28.5	12.4	0.783
–	45,000	81,500	275	261	32.2	27.6	12.0	0.788
–	40,000	72,000	260	247	32.2	26.2	11.4	0.775
–	35,000	63,000	245	233	32.2	24.8	10.8	0.759
–	30,000	54,000	231	219	32.0	23.5	10.2	0.737
–	25,000	45,000	216	205	31.0	22.0	9.6	0.720
–	20,000	36,000	197	187	28.6	21.0	9.1	0.722
–	15,000	27,500	177	168	26.2	19.2	8.4	0.726
–	10,000	18,400	153	145	23.4	17.0	7.4	0.715
–	5,000	9,500	121	115	19.3	13.8	6.0	0.696

DWT	GT	M _D [t]	L _{OA} [m]	L _{BP} [m]	B [m]	H _M [m]	D _L [m]	C _B
RO-PAX (RORO FERRY)								
–	15,000	25,000	197	183	30.6	16.5	7.1	0.613
–	12,500	21,000	187	174	28.7	15.7	6.7	0.612
–	11,500	19,000	182	169	27.6	15.3	6.5	0.611
–	10,200	17,000	175	163	26.5	14.9	6.3	0.609
–	9,000	15,000	170	158	25.3	14.5	6.1	0.600
–	8,000	13,000	164	152	24.1	14.1	5.9	0.587
–	6,500	10,500	155	144	22.7	13.6	5.6	0.560

CAR CARRIERS 

DWT	GT	M _D [t]	L _{OA} [m]	L _{BP} [m]	B [m]	H _M [m]	D _L [m]	C _B
–	30,000	48,000	220	205	32.2	31.2	11.7	0.606
–	25,000	42,000	205	189	32.2	29.4	10.9	0.618
–	20,000	35,500	198	182	32.2	27.5	10.0	0.591
–	15,000	28,500	190	175	32.2	26.5	9.0	0.548

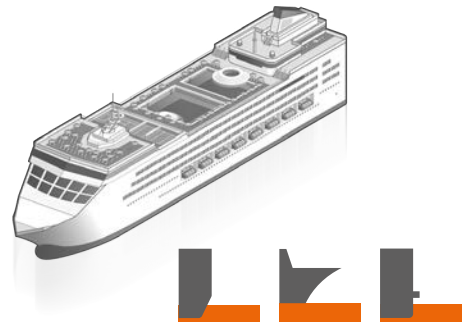
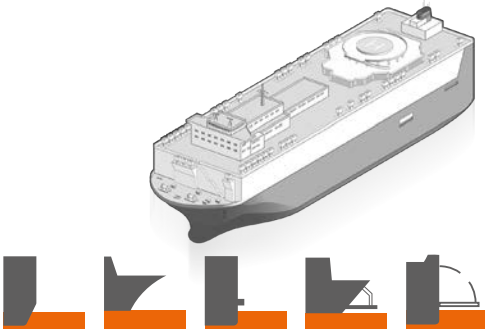

CRUISE SHIPS 

DWT	GT	M _D [t]	L _{OA} [m]	L _{BP} [m]	B [m]	H _M [m]	D _L [m]	C _B	SHIP NAME
–	225,282	105,750	362	308	47.0	22.9	9.3	0.767	Allure of the Seas
–	155,873	74,126	329	280	40.0	22.1	8.7	0.742	Norwegian Epic
–	148,528	72,193	345	293	41.0	22.7	10.1	0.580	Queen Mary 2
–	110,000	50,253	291	247	35.4	20.4	8.2	0.684	Carnival Conquest
–	102,587	52,239	273	232	36.0	19.7	8.2	0.744	Costa Fortuna
–	80,000	44,000	272	231	35.0	20.0	8.0	0.664	Generic Post Panamax
–	70,000	38,000	265	225	32.2	19.3	7.8	0.656	Generic Panamax
–	60,000	34,000	252	214	32.2	18.8	7.6	0.633	Generic Panamax
–	50,000	29,000	234	199	32.2	18.0	7.1	0.622	Generic Panamax
–	40,000	24,000	212	180	32.2	17.3	6.5	0.622	Generic Panamax
–	35,000	21,000	192	164	32.2	17.0	6.3	0.616	Generic Panamax

FAST FERRIES – MONOHULL 

DWT	GT	M _D [t]	L _{OA} [m]	L _{BP} [m]	B [m]	H _M [m]	D _L [*] [m]	C _B
–	20,000	3,200	140	133	21	5.8	2.9	0.606
–	15,000	2,400	128	120	19.2	5.4	2.7	0.618
–	10,000	1,600	112	102	16.9	5.2	2.5	0.591
–	8,000	1,280	102	87.5	15.4	5.0	2.5	0.548

*Draft excludes hydroplanes and stabilisers which may add up to 80% to vessel draft if extended. Waterline breadth is 0.8–0.9 x beam at deck level.

FAST FERRIES – CATAMARAN 

DWT	GT	M _D [t]	L _{OA} [m]	L _{BP} [m]	B [m]	H _M [m]	D _L [m]	C _B [*]
–	30,000	48,000	220	205	32.2	31.2	11.7	0.606
–	25,000	42,000	205	189	32.2	29.4	10.9	0.618
–	20,000	35,500	198	182	32.2	27.5	10.0	0.591
–	15,000	28,500	190	175	32.2	26.5	9.0	0.548

*Block coefficient is calculated using total width of both hulls, maximum waterline breadth of each hull is approximately 25% of the beam at deck level (given).

SHIP LIMITS

In many parts of the world, ships sizes are limited due to locks, channels and bridges. Common limiting dimensions are length, beam, draft and air draft.

L_{OA}	Length overall of ship
B	Beam (or breadth)
D_L	Laden Draft
D_A	Air Draft



CHINAMAX

Chinamax relates to port capacity at multiple harbours in China. The maximum is 380,000 – 400,000 DWT but a restriction of 380,000 DWT was imposed on ships.

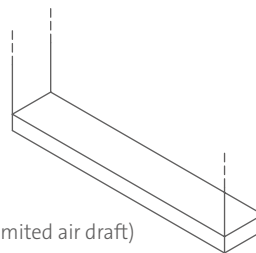

(unlimited air draft)

L_{OA}	≤ 360 m
B	≤ 65 m
D_L	≤ 24 m
D_A	No Limit

NEW PANAMAX

The new (third) Panama Canal locks were opened in 2016. Some existing ships are too large for the current locks (Post-Panamax) and new purpose designed ships will be able to transit.

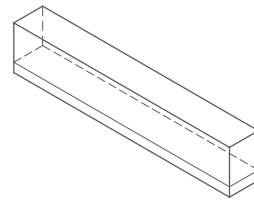

L_{OA}	≤ 366 m
B	≤ 49 m
D_L	≤ 15.2 m
D_A	≤ 57.91 m

PANAMAX

The (second) Panama Canal locks were commissioned in 1914 and have dictated the design of many ships ever since.

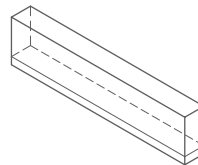

L_{OA}	≤ 294.13 m
B	≤ 32.31 m
D_L	≤ 12.04 m
D_A	≤ 57.91 m

SUEZMAX

The Suez Canal allows practically unrestricted passage, except for a few fully laden oil tankers.

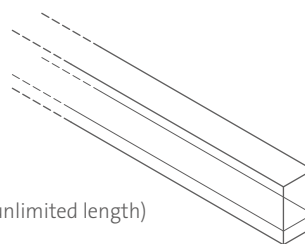

(unlimited length)

L_{OA}	No Limit
B	≤ 50 m
D_L	≤ 20.1 m
D_A	≤ 68 m

Q-MAX

Q-max is a prismatic LNG carrier of the largest size able to dock at terminals in Qatar, in particular limited by draft in the region.

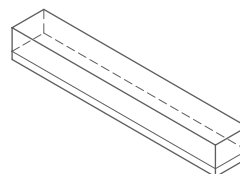

L_{OA}	≤ 345 m
B	≤ 53.8 m
D_L	≤ 12 m
D_A	≤ 34.7 m

SEAWAYMAX

Seawaymax are the largest ships which can transit locks on the St. Lawrence Seaway into Lake Ontario. Larger ships operate within the lakes but cannot pass the locks.

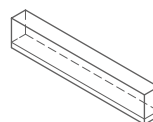

L_{OA}	≤ 225.6 m
B	≤ 23.8 m
D_L	≤ 7.92 m
D_A	≤ 35.5 m

SHIP LOADS

Most berths are designed to import or export cargo, sometimes both. The different draft and displacement of the ship in these cases can be important to the fender design.

IMPORT BERTHS

For import berths the ship will mostly arrive fully or partly loaded. Over-sized ships might use the berth but with a draft restriction.

EXPORT BERTHS

At export berths ships usually arrive in ballast condition, with water inside special tanks to make sure the ship is properly trimmed, propeller and rudder submerged and the ship stable and manoeuvrable. Ballast water is discharged as the cargo is loaded.



PASSENGER, CRUISE & RORO BERTHS

Such ships carry very little cargo so their draft changes only a small amount between loaded and unloaded condition. In these cases the ships should always be considered as fully loaded for calculating berthing energy. Minimum draft is usually at least 90% of fully laden draft.

SHIPYARDS

Only when ships are under construction or being repaired is it feasible they could be in light condition – without cargo or ballast. Special care is needed because hull features like beltings might sit over the fenders, or underwater protrusions might be at fender level.

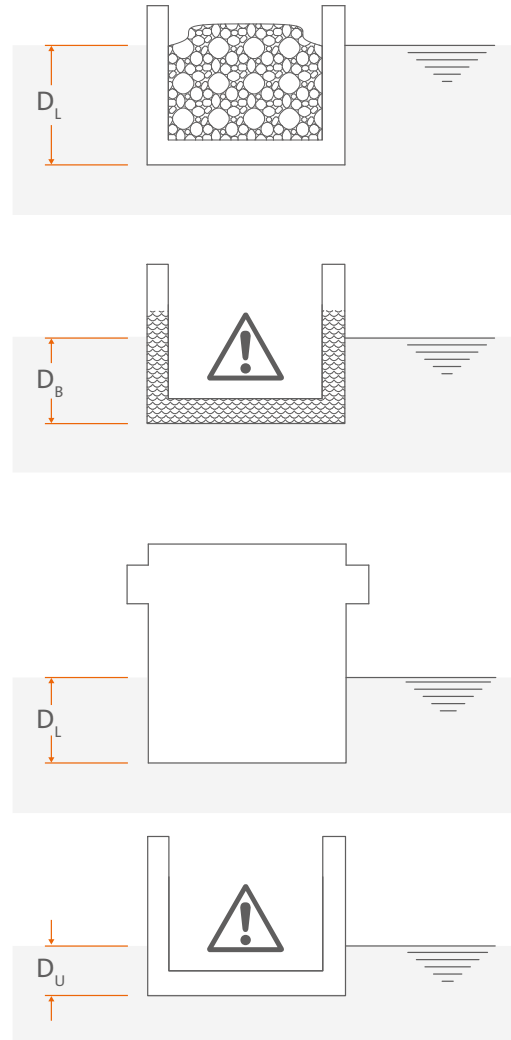

In case the fenders are designed for ships at ballast draft or partly loaded, care is needed in case the ship departs fully loaded but must return due to some technical problem. On import/export berths the ship should not be considered as light or unladen.

BALLAST BLOCK COEFFICIENT

For “full form” ships, particularly tankers and bulk carriers, it is common to assume that Block Coefficient (C_B) does not vary with actual draft (D) under any load condition. For other ship types the Block Coefficient will reduce slightly as draft reduces.

Tankers & Bulk Carriers	$D_L \geq D \geq D_U$	$C_B = \frac{M_D}{L_{BP} \times B \times D_L \times \rho_{sw}}$
	$D_L \geq D \geq 0.6 D_L$	
Other Ship types	$D < 0.6 D_L$	$C_B = 0.9 \times \frac{M_D}{L_{BP} \times B \times D_L \times \rho_{sw}}$

SHIP APPROACH

Depending on the ship and berth type, vessels can approach the structure in different ways. These different types of approach must be considered carefully to understand the true point of contact on the hull, the velocity direction (vector) and other factors which might cause the fender to compress at angles, shear under friction, cantilever etc. The most common cases are:

SIDE BERTHING

- ▶ Ship is parallel or at a small angle to the berthing line.
- ▶ Velocity vector is approximately perpendicular to the berthing line.
- ▶ Ship rotates about the point of contact with fender(s) which dissipates some kinetic energy.
- ▶ Contact is typically between 20% and 35% from bow, depending on bow radius and geometry.
- ▶ Ship may hit one, two, three or more fenders depending on their size and the bow radius of the ship.
- ▶ If velocity is not exactly perpendicular to berthing line then there is some shear in the fenders due to friction.

END BERTHING

- ▶ Ship is moving forward or aft towards the structure.
- ▶ Common approach to RoRo ramps and pontoons, but sometimes applied to barges and heavy load ships.
- ▶ Berthing angles usually small but could result in a single fender or very small area coming into contact with the ship bow or stern berthing.
- ▶ Berthing speeds can be high and there is little if any rotation of ship about point of contact, so fender must absorb all kinetic energy.
- ▶ Virtual mass (added mass) of entrained water is quite low due to more streamlined profile of hull.

DOLPHIN BERTHING

- ▶ Ship is parallel or at a small angle to the berthing line.
- ▶ Common method for oil/gas terminals where velocity vector is mostly perpendicular to the berthing line.
- ▶ Also common for some RoRo berths where velocity vector may include a large forward/aft component (towards ramp) that can produce high shear forces.
- ▶ Contact on oil/gas terminals is often between 30% and 40% of length from bow or stern, usually on the flat mid-section of the hull.
- ▶ Contact on RoRo berths is usually 25% and 35% of length from bow, but often at midships on outer dolphins.
- ▶ If velocity is not exactly perpendicular to berthing line then there is some shear in the fenders due to friction.

LOCK APPROACH

- ▶ Ship approach is usually coaxial with the lock center-line.
- ▶ If ship is "off center" the bow can strike the berth corner so berthing line is a tangent to the ship hull.
- ▶ Velocity vector has a large forward component, so will create high and sustained shear forces due to friction.
- ▶ Point of contact can be far forward so large bow flares should be considered.
- ▶ Point of contact can also be a long way aft, 30% of length or more from the bow so little rotation to dissipate berthing energy.

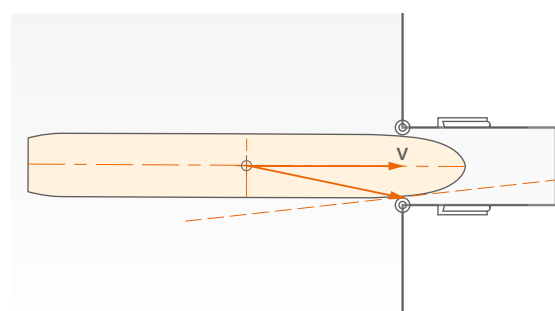
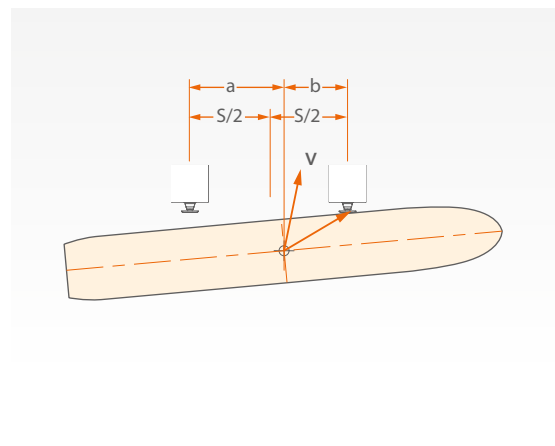
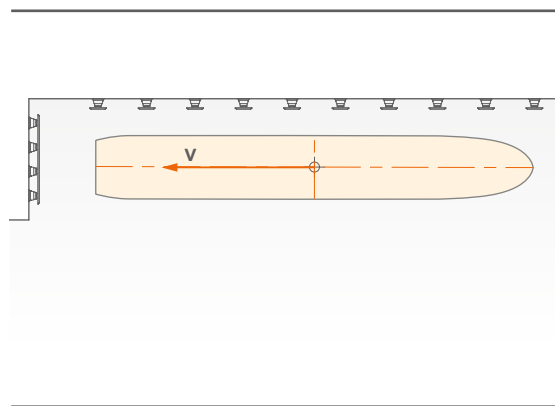
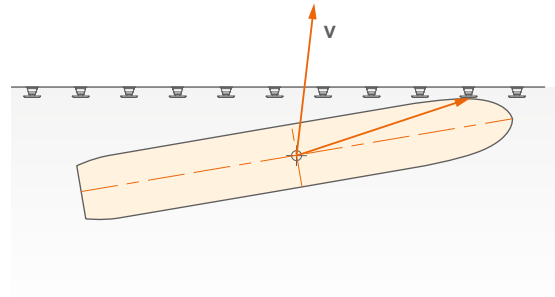

ADDED MASS COEFFICIENT (C_M)

When a ship moves sideways towards a berth it drags along a mass of water. As the ship's motion is reduced by the fenders, the momentum of the water pushes it against the ship hull which increases the total kinetic energy to be absorbed. The added mass factor takes into account the actual mass (displacement) of the ship and the virtual mass of the water.

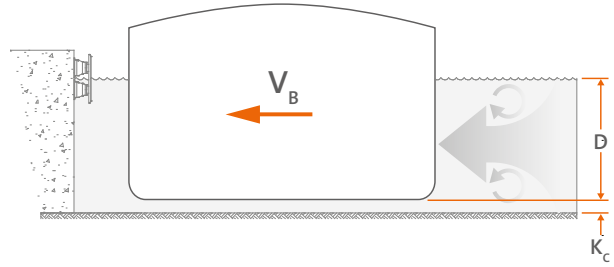

There are different estimates about the true virtual mass of water moving with the ship, but it is agreed that the effect is smaller in deep water and greater in shallow water. This is due to limited under keel clearance (K_c) available for water that pushes the ship to escape. Some formulas for Added Mass Coefficient consider this, others account for it separately within the Berth Configuration Factor (C_c). The common formulas for Added Mass Coefficient are:

PIANC METHOD (2002)

PIANC amalgamated the methods below and the Berth Configuration Coefficient (C_c) in their 2002 report, considering the effect of added mass and under-keel clearance within the same term. This method is now adopted by EAU-2004 and some other codes. With this method $C_c=1$.

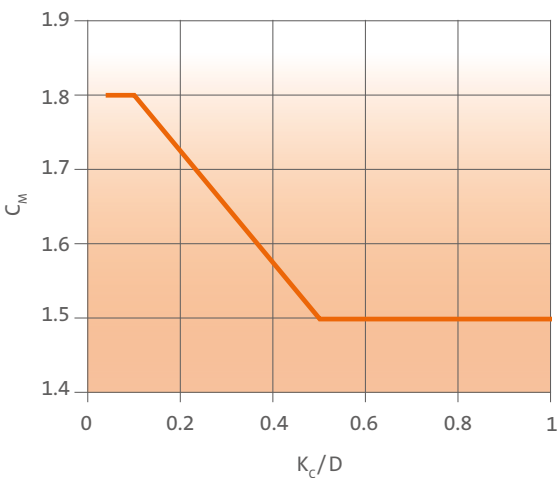

SHIGERU UEDA METHOD (1981)

Based on model testing and field observations, this method is widely used in Japan and yields similar or slightly lower values compared to Vasco Costa Method.

VASCO COSTA METHOD (1964)

First proposed in his publication "The Berthing Ship" (1964), this method remains the most commonly used by international standards including BS6349 and other codes.

$$\frac{K_c}{D} \leq 0.1 \rightarrow C_M = 1.8$$

$$0.1 < \frac{K_c}{D} < 0.5 \rightarrow C_M = 1.875 - 0.75 \left(\frac{K_c}{D} \right)$$

$$\frac{K_c}{D} \geq 0.5 \rightarrow C_M = 1.5$$

$$\text{where } D_B \leq D \leq D_L$$

$$C_M = 1 + \frac{\pi \times D}{2 \times B \times C_B}$$

$$C_M = 1 + \frac{2 \times D}{B}$$

ECCENTRICITY COEFFICIENT (C_E)

If the ship's velocity vector (v) does not pass through the point of contact with the fender then the ship rotates as well as compresses the fender. The rotation dissipates part of the ship's kinetic energy and the remainder must be absorbed by the fender.

If the distance between the velocity vector and the fender contact point increases (i.e. is closer to the bow) then C_E reduces, and vice versa. If the fender contact point is directly opposite the ship's center of mass during side or end berthing then the ship does not rotate ($C_E \approx 1$).

SIDE BERTHING

Typically: $0.4 \leq C_E \leq 0.7$

$$0^\circ \leq \alpha \leq 20^\circ$$

$$60^\circ \leq \gamma \leq 80^\circ$$

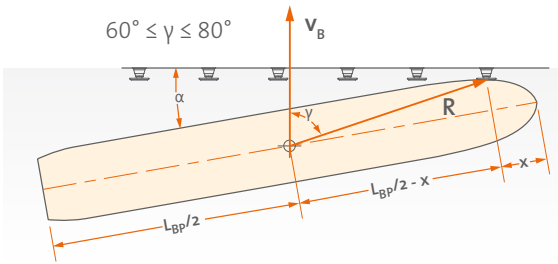

MIDSHIPS CONTACT

Typically: $C_E = 1.0$

$$x = L_{BP}/2$$

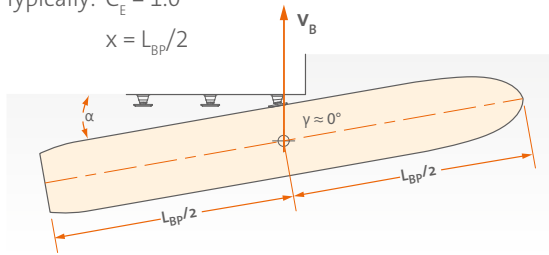

$$C_E = \frac{\text{Kinetic energy imparted to fender}}{\text{Total kinetic energy of ship}} \leq 1$$

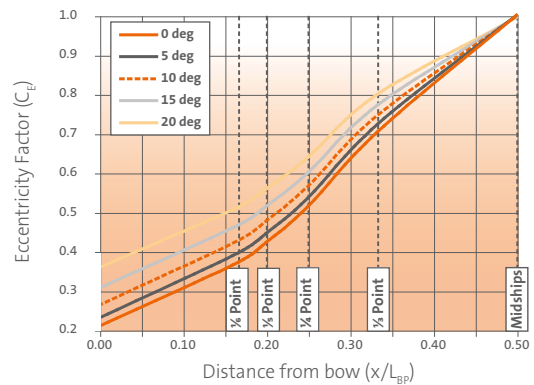

RORO BERTHS

Typically: $0.4 \leq C_E \leq 0.7$ (Side)

$$C_E = 1.0 \text{ (End)}$$

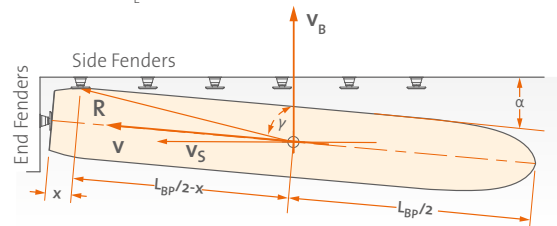

$$C_E = \frac{K^2 + (R^2 \cos^2(\gamma))}{K^2 + R^2}$$

$$K = (0.19 \times C_B + 0.11) \times L_{BP}$$

$$R = \sqrt{\left(\frac{L_{BP}}{2} - x\right)^2 + \left(\frac{B}{2}\right)^2}$$

$$\gamma = 90 - \alpha - \text{asin}\left(\frac{B}{2R}\right)$$

Common approximations of Eccentricity Factor are made for quick energy calculations:

Fifth point berthing: $C_E \approx 0.45$

Quarter point berthing: $C_E \approx 0.50$

Third point berthing: $C_E \approx 0.70$

Midships berthing: $C_E \approx 1.00$

End berthing (RoRo): $C_E \approx 1.00$



The special case of $\gamma = 90^\circ$ should be used with care.

Example for a 100,000 DWT fully laden oil tanker (see page 9), assuming a third point side berthing contact (typical for dolphins) and 5° berthing angle:

$$M_D = 125,000 \text{ t}$$

$$B = 43.0 \text{ m}$$

$$L_{BP} = 236 \text{ m}$$

$$D_L = 15.1 \text{ m}$$

$$C_B = \frac{125,000}{1.025 \times 236 \times 43 \times 15.1} = 0.796$$

$$K = (0.19 \times 0.796 + 0.11) \times 236 = 61.7 \text{ m}$$

$$R = \sqrt{\left(\frac{236}{2} - \frac{236}{3}\right)^2 + \left(\frac{43}{2}\right)^2} = 44.8 \text{ m}$$

$$\gamma = 90^\circ - 5^\circ - \text{asin}\left(\frac{43}{2 \times 44.8}\right) = 56.3^\circ$$

$$C_E = \frac{61.7^2 + (44.8^2 \times \cos^2(56.3^\circ))}{61.7^2 + 44.8^2} = 0.761$$

BERTH CONFIGURATION COEFFICIENT (C_c)

During the final stage of berthing a ship pushes a volume of water towards the structure. Depending on the type of structure the water might flow freely through the piles or it may get trapped between the hull and the concrete. The cushioning effect of the water will also depend on the under keel clearance (K_c) and the berthing angle of the ship (α). A large space under the ship hull – perhaps at high tide or when berthing in ballast condition – will allow water to escape under the ship. When the ship does not berth parallel then water may escape towards the bow or stern.

SOLID STRUCTURE

$$\frac{K_c}{D} \leq 0.5 \rightarrow C_c \cong 0.8 (\alpha \leq 5^\circ)$$

$$\frac{K_c}{D} > 0.5 \rightarrow C_c \cong 0.9 (\alpha \leq 5^\circ)$$

when $\alpha > 5^\circ \rightarrow C_c = 1.0$

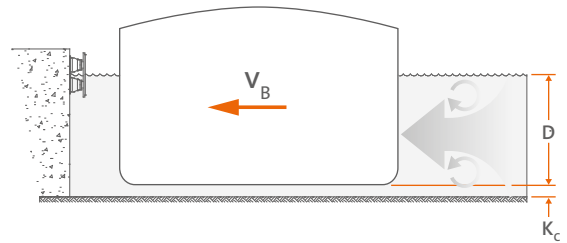

PARTLY CLOSED STRUCTURE

$$\frac{K_c}{D} \leq 0.5 \rightarrow C_c \cong 0.9 (\alpha \leq 5^\circ)$$

$$\frac{K_c}{D} > 0.5 \rightarrow C_c \cong 1.0 (\alpha \leq 5^\circ)$$

when $\alpha > 5^\circ \rightarrow C_c = 1.0$

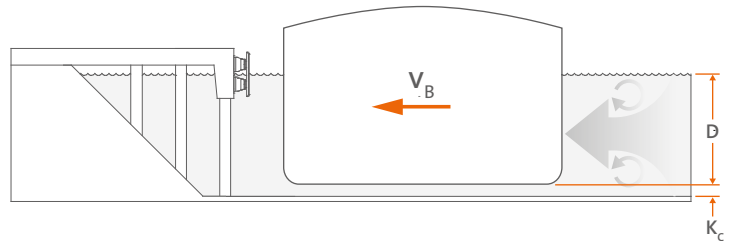

OPEN PILE STRUCTURE

$C_c = 1.0$

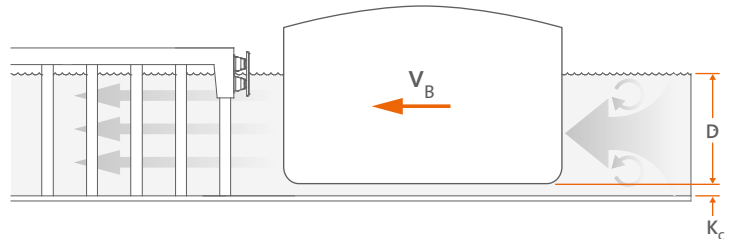

The PIANC method for Added Mass Coefficient (C_M) takes account of the under keel clearance so in this case $C_c=1$. If the Vasco Costa or Shigeru Ueda methods are used for Added Mass then C_c may be considered according to above guidelines.

SOFTNESS COEFFICIENT (C_s)

Hard fenders may cause the ship hull to deflect elastically which absorbs a small amount of energy. Modern fenders are mostly regarded as 'soft' so this effect does not absorb energy.

$$\Delta_f \leq 0.15 \text{ m} \rightarrow C_s \leq 0.9$$

$$\Delta_f \geq 0.15 \text{ m} \rightarrow C_s \leq 1.0$$

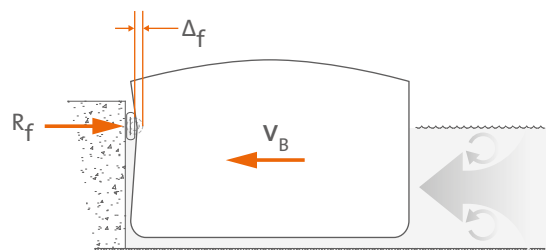

BERTHING SPEEDS

Ship berthing speeds are the most important variable in the energy calculation. The speed is measured perpendicular to the berthing line (v_b) and depends on several factors which the designer must consider:

- ▶ Whether or not the berthing ship is assisted by tugs
- ▶ The difficulty of the approach manoeuvre onto the berth
- ▶ How exposed the berth might be including currents and winds which push the ship
- ▶ The size of the ship and whether it is berthing fully laden, part laden or in ballast

BS6349, PIANC and many other standards adopt the Brotsma berthing speeds graph. Selected values from the curves are also provided in the table below. The most commonly used berthing conditions are represented by lines 'b' and 'c'.

- a: Easy berthing, sheltered
- b: Difficult berthing, sheltered
- c: Easy berthing, exposed
- d: Good berthing, exposed
- e: Difficult berthing, exposed

Displacement M_D [t]	a	b	c	d*	e**
1,000	0.179	0.343	0.517	0.669	0.865
3,000	0.136	0.269	0.404	0.524	0.649
5,000	0.117	0.236	0.352	0.459	0.558
10,000	0.094	0.192	0.287	0.377	0.448
15,000	0.082	0.169	0.252	0.332	0.391
20,000	*	0.153	0.228	0.303	0.355
30,000	*	0.133	0.198	0.264	0.308
40,000	*	0.119	0.178	0.239	0.279
50,000	*	0.110	0.164	0.221	0.258
75,000	*	0.094	0.141	0.190	0.223
100,000	*	0.083	0.126	0.171	0.201
150,000	*	*	0.107	0.146	0.174
200,000	*	*	0.095	0.131	0.158
250,000	*	*	0.086	0.120	0.146
300,000	*	*	0.080	0.111	0.137
400,000	*	*	*	0.099	0.124
500,000	*	*	*	0.090	0.115

*Design berthing speeds below 0.08 m/s are not recommended.
 **PIANC states curves 'd' and 'e' may be high and should be used with caution.

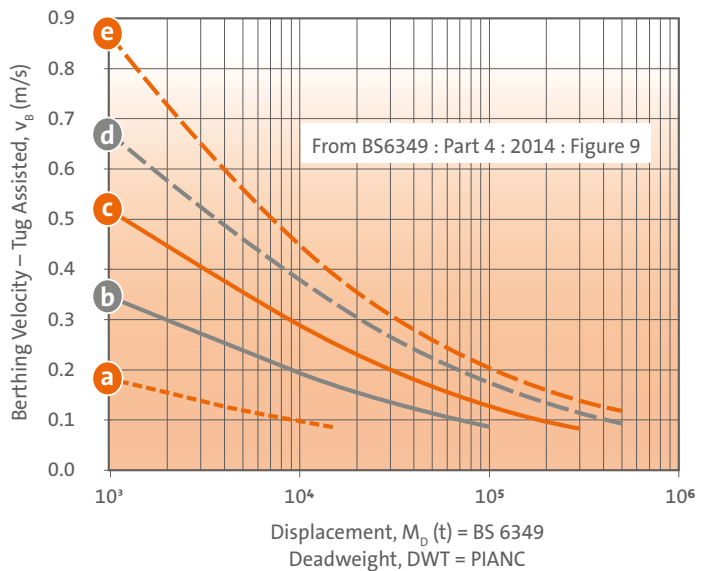

Berthing without Tugs

All speeds in the graph and table assume conventional ships berthing with tug assistance. If tugs are not used then designers should refer to graphs provided in:

- (i) EAU 2004 (Fig. R40-1)
- (ii) ROM 2.0-11 (Table 3.4.2.3.5.2)

These codes suggest that berthing speeds without tugs can be 2–3 times higher in unfavourable conditions, and 1.3–2.3 times higher in favourable conditions.

Berthing speeds are for conventional commercial ships. For unusual ship types including high speed monohulls and catamarans, barges, tugs and similar craft please refer to ShibataFenderTeam for advice. For navy ships designers can refer to US Department of Defense guidelines, UFC 4-152-01 (figures 5.3 & 5.4).

BERTHING ENERGY

The berthing energy of the ship is considered in two stages:

NORMAL ENERGY (E_N)

The normal energy may occur routinely and regularly during the lifetime of the berth without causing damage to the fender. It will consider:

- ▶ The full range of ships using the berth
- ▶ Likely displacements when berthing (not necessarily fully laden)
- ▶ Berthing frequency
- ▶ Ease or difficulty of the approach manoeuvre
- ▶ Local weather conditions
- ▶ Strength of tide or currents
- ▶ Availability and power of tugs

ABNORMAL ENERGY (E_A)

The abnormal energy arises rarely during the life of the fender and should not result in any significant fender damage. It will consider:

- ▶ The effect of fender failure on berth operations
- ▶ Occasional exceptional ships
- ▶ Large ships with very slow speeds that need exceptional skill during docking manoeuvres
- ▶ Hazardous cargoes and environmental impact
- ▶ Human error
- ▶ Equipment failure

NORMAL ENERGY

The normal kinetic berthing energy (E_N) of the ship is determined as: $E_N = 0.5 \times M_D \times v_B^2 \times C_M \times C_E \times C_C \times C_S$

SAFETY FACTOR (η)

The safety factor takes account of events and circumstances that may cause the normal energy to be exceeded. PIANC states that “the designers’ judgement should be paramount in determining the appropriate factor”. Care should be taken to avoid excessive safety factors which will render the fenders too large or too hard for smaller ships, particularly when there is a wide range in the size of ships using the berth. Some safety factors are suggested by PIANC (also adopted by EAU-2004, other codes and guidelines):

VESSEL CLASS	LARGEST	SMALLEST	COMMENTS & INTERPRETATIONS	
Tankers	1.25 ^A	1.75 ^B	A: Suezmax and above	B: Handymax and smaller
Bulk carriers	1.25 ^A	1.75 ^B	A: Capesize and above	B: Handymax and smaller
Gas carriers	1.50–2.00		No PIANC guidance. Safety critical so high factor required.	
Container ships	1.50 ^A	2.00 ^B	A: Post-Panamax and above	B: Panamax and smaller
General cargo, freighters	1.75		Use higher factors and speeds if tugs are unavailable.	
RoRo & Ferries	≥ 2.00		High safety factors may be necessary on the most exposed berths.	
Car carriers	2.00		No PIANC guidance. Large wind area can make berthing difficult.	
Cruise ships	2.00		No PIANC guidance. Large wind area can make berthing difficult.	
Fast ferries	≥ 2.00		No PIANC guidance. Ships have limited slow speed manoeuvrability.	
Tugs, workboats	2.00		Come in all shapes and sizes. Many unknowns.	

Unless otherwise stated, suggested values are from PIANC 2002 (Table 4.2.5).

ABNORMAL ENERGY

The abnormal kinetic berthing energy (E_A) of the ship is determined as: $E_A = E_N \times \eta$



The energy capacity of the fender (E_{RPD}) must always be greater than the abnormal energy (E_A). Fender selection should also consider manufacturing tolerance, compression angle, operating temperatures and compression speeds. Please refer to page 26.

$$E_{RPD} \geq \frac{E_A}{f_{TOL} \times f_{ANG} \times f_{TEMP} \times f_{VEL}}$$

PART 2

FENDER SELECTION GUIDE

Fender Selection	24
Energy Capacity & Environmental Factors	26
Fender Efficiency.....	27
Fender Applications.....	28
Fender Spacing.....	29
Multiple Fender Contact	30
Bending Moments	31
Panel Construction	32
Fender Panels.....	33
Pressure Distribution & Low Friction Pads	34
Low Friction Pads & Fixings	35
Chain Design.....	36
Chain Droop & Bracket Design.....	37
Wheel & Roller Fenders	38
Foam Fender Design	40
Angular Compression.....	41
Foam Fender Installation	42
Donut Fenders.....	44
Donut Fender Applications	45
Pneumatic Fender Installation	46
Hydropneumatic Fenders	47
Environment & Corrosion Prevention.....	48
Anodes, Paint Coatings & Stainless Steel.....	49
Performance Testing.....	50
Quality Certificates.....	53
Project Questionnaire.....	54
Conversion Factors.....	56
After Sales & Warranty	58

FENDER SELECTION

Before selecting fenders the designer should review all project requirements and other available information including reference design codes and guidelines. The list below acts as a useful checklist to identify which information is known from the specifications and which is missing inputs, requiring assumptions or further research. Some design data is derived from calculations so it is also important to highlight if these calculations were based on known and/or assumed information.



- Ship sizes
- Ship types or classes
- Loaded or ballast condition
- Under-keel clearances

- Berthing mode
- Frequency of berthing
- Approach speed
- Berthing angles
- Point of impact

- Bow flare angles
- Bow radius
- Beltings
- Side doors and hull protrusions
- Freeboard levels

- Berth construction
- Cope level & soffit levels
- Available width for fender footprint
- Seabed level
- Design tidal ranges
- New or existing structure
- Construction or expansion joints

- Temperature ranges
- Ice flows
- Local corrosivity

FENDER SELECTION

Other design criteria for the fenders may be specified or assumed according to best practice, type of berth and local conditions using the designer's experience. There are many aspects to consider in fender design and the correct selection will increase performance, improve operations and reduce maintenance. Sometimes the smallest detail like using thicker low-friction face pads or adding a corrosion allowance to chains can extend service life for very little extra cost.



- ☑ Fender type (fixed, floating etc.)
- ☑ Fender size and grade
- ☑ Temperature, angular and speed factors
- ☑ Manufacturing tolerance
- ☑ Type approval to PIANC, ASTM or ISO
- ☑ Testing, certification and witnessing

- ☑ Hull pressures
- ☑ Panel height and width
- ☑ Edge chamfers or bevels
- ☑ Bending moments
- ☑ Open or closed box panel design
- ☑ Steel grades (yield, low temperature etc.)
- ☑ Corrosion allowances

- ☑ Paint durability (ISO12944 etc.)
- ☑ Dry film thickness
- ☑ Paint type
- ☑ Topcoat colours

- ☑ Low-friction face pad material
- ☑ Wear allowance
- ☑ Colour
- ☑ Face pad size and weight
- ☑ Fixing method and stud grade

- ☑ Weight, shear and tension chains
- ☑ Link type, grade and finish
- ☑ Connection brackets on structure
- ☑ Connection to fender panel
- ☑ Adjustment or toleranced chains
- ☑ Working load safety factor
- ☑ Weak link (PIANC)
- ☑ Corrosion allowance

- ☑ Cast-in or retrofit anchors
- ☑ Material grade and finish
- ☑ Lock tabs or lock nuts
- ☑ Special washers

ENERGY CAPACITY & ENVIRONMENTAL FACTORS

In all cases the fender must have an energy absorption capacity greater than or equal to the ship's calculated abnormal berthing energy (or the specification's stated Required Energy as defined by PIANC). Due allowance should be made for fender manufacturing tolerances (f_{TOL}) and the effects of temperature, compression speed or rate and compression angles (horizontal and vertical).

Different fender types and materials respond in different ways to these effects so please consult the ShibataFenderTeam product catalogue or ask for specific data for the type and material being used. Data shown is typical for SPC Fenders.

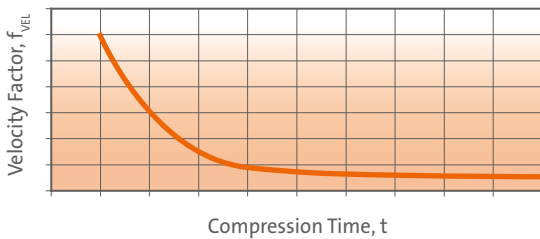
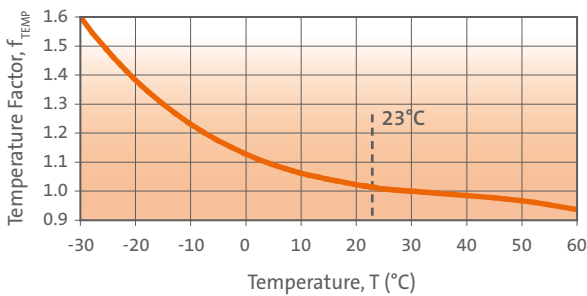
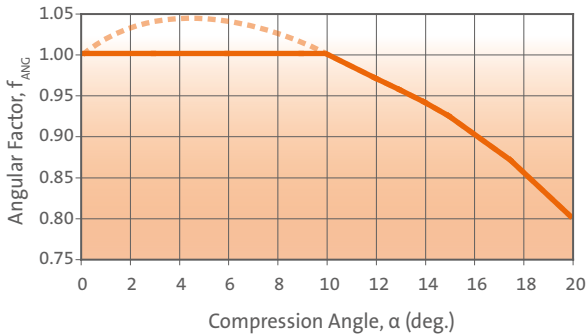

MINIMUM FENDER ENERGY (E_f)

$$E_f = E_{RPD} \times f_{TOL} \times f_{ANG} \times f_{TEMP} \times f_{VEL}$$

MAXIMUM FENDER REACTION (R_f)

$$R_f = R_{RPD} \times f_{TOL} \times f_{ANG} \times f_{TEMP} \times f_{VEL}$$

ANGULAR FACTOR (f_{ANG})

Some fenders are affected by the compression angle because some areas of the rubber or foam are more compressed than others. The datum angle is 0°.

The fender's minimum energy will occur at the largest compression angle. f_{ANG} should be determined using the compound (vertical and horizontal) angle for cone & cell fenders. f_{ANG} should be determined using the individual vertical and horizontal factors for linear types like arch, cylindrical and foam fenders.

Angular factors > 1.0 are usually ignored.

TEMPERATURE FACTOR (f_{TEMP})

Rubber and foam, like most materials, gets softer when hot, stiffer when cold. The datum temperature is 23°C ($f_{TEMP} = 1$).

The fender's minimum energy will occur at the highest operating temperature, the maximum reaction force will occur at the lowest operating temperature.

VELOCITY FACTOR (f_{VEL})

Rubber and foam have visco-elastic properties which means they work partly like a spring, partly like a shock absorber. The datum initial impact speed is 0.15 m/s.

This factor depends on strain rate and the size of the fender, so the velocity factor is determined from the compression time. The fender's maximum reaction force will occur at the highest impact speed.

FENDER TOLERANCE (f_{TOL})

f_{TOL} is the performance tolerance for the fender type, typically ± 10% for moulded rubber fenders, ± 20% for extruded rubber fenders and ± 15% for foam fenders.

For historical reasons the tolerance of Pneumatic Fenders is 0% for energy (termed the 'guaranteed energy absorption' or GEA) and ± 10% for reaction.

RATED PERFORMANCE DATA (RPD)

RPD is the published or catalogue performance of the fender at 23°C, 0.15 m/s initial impact speed, 0° compression angle and mid-tolerance.

E_{RPD} is the fender energy at RPD

R_{RPD} is the fender reaction at RPD

FENDER EFFICIENCY

Every fender type has different characteristics. Any comparison will start with reviewing the ratio of energy at low end tolerance (E_{LET}) and reaction at high end tolerance (R_{HET}). The efficiency of the fender (Eff) is expressed as the ratio of the force that is transferred into the structure per unit of energy absorbed.

Single Cone	Dual Cone	Cylindrical	Pneumatic	Foam
1 pce/system SPC 1000 G2.1	2 pcs/system SPC 800 G2.0	1 pce/system 1400 x 700 x 2300 L	1 pce/system 2000 x 3500 (0.8)	1 pce/system OG 2000 x 4000 STD
				
$E_{LET}: 501 \times 0.9 = 451 \text{ kNm}$ $R_{HET}: 955 \times 1.1 = 1051 \text{ kN}$ Eff: $451/1051 = 0.43$	$E_{LET}: 498 \times 0.9 = 448 \text{ kNm}$ $R_{HET}: 1186 \times 1.1 = 1305 \text{ kN}$ Eff: $448/1305 = 0.34$	$E_{LET}: 506 \times 0.9 = 455 \text{ kNm}$ $R_{HET}: 1771 \times 1.1 = 1948 \text{ kN}$ Eff: $455/1948 = 0.23$	$E_{LET}: 491 \times 1.0 = 491 \text{ kNm}$ $R_{HET}: 1315 \times 1.1 = 1447 \text{ kN}$ Eff: $491/1447 = 0.34$	$E_{LET}: 540 \times 0.85 = 459 \text{ kNm}$ $R_{HET}: 1005 \times 1.15 = 1156 \text{ kN}$ Eff: $459/1156 = 0.40$

This comparison only considers energy, reaction and manufacturing tolerances. A more detailed comparison would take account of compression angles, temperature and impact speed. There will be other factors too, including suitability for small or large tides, fender height and deflection, low level impacts, hull pressure, beltings, non-marking fenders, ease of installation, maintenance, durability and price.

RISK ANALYSIS

Each assumption made in the design carries a risk. It might not be commercially viable to protect against every very small risk, but if there is a high probability of some events, and these events have important consequences, then a risk analysis will assist designers to select the best fender. The probability and frequency of particular events happening during the working life of the fenders or structure can be estimated.

$$P = \left(1 - \left(1 - \frac{1}{Y}\right)^N\right) \times 100\%$$

P = The probability an event is equalled (or exceeded) at least once in a given time

Y = The return period of an event

N = Service life

EXAMPLE 1

The largest ship berths 12 times per year. It hits fenders at highest speed once in 100 berthings. It berths with largest angle once in 40 berthings. Fender design life (N) is assumed in this case to be 25 years. The likelihood of this event at any tide level is:

$$Y = 1 / \left(12 \times \frac{1}{100} \times \frac{1}{40}\right) = 333 \text{ years}$$

$$P = \left(1 - \left(1 - \frac{1}{333}\right)^{25}\right) \times 100\% = 7.2\%$$

Designers may regard this as significant

EXAMPLE 2

The largest ship berths 12 times per year. It hits fenders at highest speed once in 100 berthings. It berths with largest angle once in 40 berthings. Fender design life (N) is assumed in this case to be 25 years. The probability of this event happening at LAT (every 18.5 years) is:

$$Y = 1 / \left(12 \times \frac{1}{100} \times \frac{1}{40} \times \frac{1}{18.5}\right) = 6,167 \text{ years}$$

$$P = \left(1 - \left(1 - \frac{1}{6,167}\right)^{25}\right) \times 100\% = 0.4\%$$

Designers may regard this as insignificant

FENDER APPLICATIONS

Correctly selected fenders will be an asset to a berth, providing smooth and trouble-free operations.

VESSEL TYPES	SPC	CSS	FE	PM	PVT	SX	SX-P	SH	CYL	RF	WF	PNEU	HYD-PN	FOAM	DONUT	EXT
Tankers																
Bulk Carriers																
Gas Carriers																
Container Ships																
General Cargo																
Barges																
RoRo Ferries																
Car Carriers																
Cruise Ships																
Fast Ferries																
Navy Surface Ships																
Submarines																

APPLICATIONS	SPC	CSS	FE	PM	PVT	SX	SX-P	SH	CYL	RF	WF	PNEU	HYD-PN	FOAM	DONUT	EXT
Linear wharf/dock																
Dolphins																
Monopiles																
Low-freeboard ships																
Belted ships																
Large bow flares																
Large tide zones																
Small tide zones																
Cruise Ships																
Ice Zones																
Lead-in structures																
Lay-by berths																
RoRo ramp fenders																
Lock entrances																
Lock walls																
Shipyards																
Ship-to-ship																
Ship carried fenders																
Temporary berths																

 Generally suitable fender type

 Suitable for some applications in this category

 Requires specialist product knowledge - Ask ShibataFenderTeam

FENDER SPACING

Design standards like BS6349 say that a fender can be a single system or several systems close enough together to all be mobilized during the berthing impact. The ship's bow radius, bow flare angle and berthing angle will determine the fender selection and the distance between fenders.

BOW RADIUS

Ships are often assumed to have a constant radius hull curvature from bow to the parallel side body (PSB). Streamlined ships which are designed for high speeds (i.e. container, cruise and some RoRo ships) will have a bow curvature that extends further back on the hull. A ship designed to carry maximum cargo (i.e. bulk carrier or oil tanker) will have a shorter bow curvature.

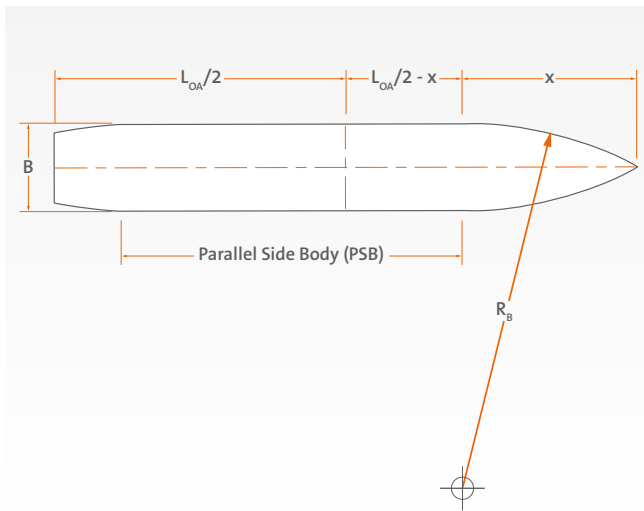

FENDER PITCH

Large spaces between fenders may allow ships, especially smaller ones, to contact the structure. At all times there should be a clearance between ship and structure, usually 5–15% of the uncompressed fender projection (including any fender panel, spacer spools etc.).

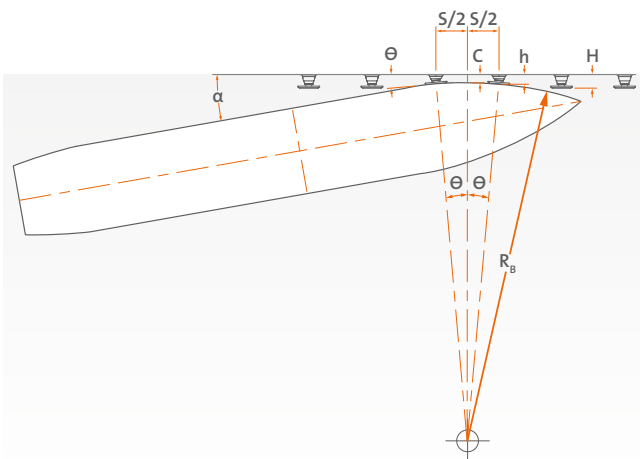

The amount of bow curvature is sometimes estimated based on the ship's block coefficient:

$$C_B < 0.6 \rightarrow \frac{x}{L_{OA}} \approx 0.3$$

$$0.6 \leq C_B < 0.8 \rightarrow \frac{x}{L_{OA}} \approx 0.25$$

$$C_B \geq 0.8 \rightarrow \frac{x}{L_{OA}} \approx 0.2$$

Bow radius can be calculated as:

$$R_b = \frac{x^2}{B} + \frac{B}{4}$$

The distance between fenders is:

$$S \leq 2 \sqrt{R_b^2 - (R_b - h + C)^2}$$

S = Fender spacing

R_b = Bow radius

H = Uncompressed fender height

h = Compressed fender height

C = Clearance to wharf

α = Berthing angle

θ = Tangential angle with fender

The contact angle with the fender is:

$$\theta = \text{asin} \left(\frac{S}{2 \times R_b} \right)$$

BS6349 suggests that:

$$S \leq 0.15 L_s$$

L_s = Overall length of shortest ship

MULTIPLE FENDER CONTACT

Depending on bow radius and the fender spacing, ships may contact more than one fender when berthing. If this happens, the total berthing energy will be absorbed according to the respective deflection of each fender.

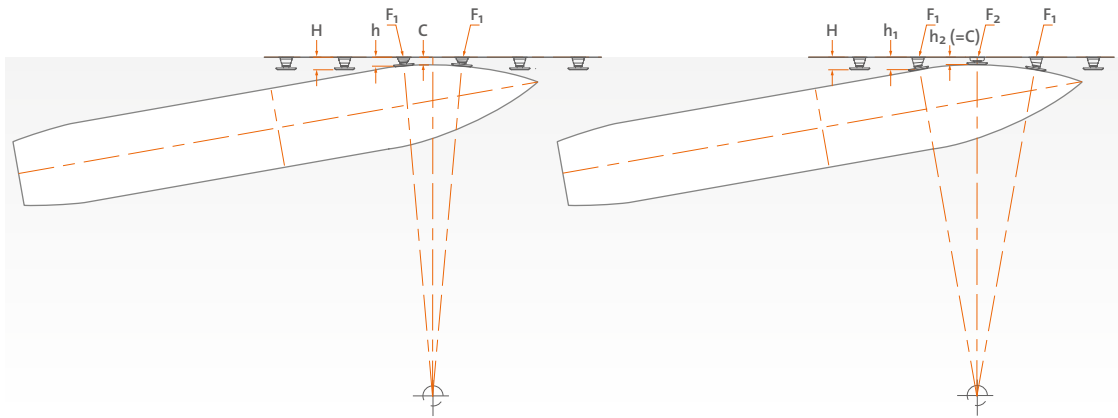

EVEN FENDER CONTACT (2, 4 ETC.)

- ▶ Energy is divided equally between two fenders
- ▶ Reduced deflection of each fender
- ▶ Greater total reaction into the berth structure
- ▶ Clearance (C) will depend on bow radius and bow flare
- ▶ Small bow radius ships may get closer to structure

BOW FLARE

The angle of the ship's bow at the point of contact may reduce the effective clearance between the hull and the structure:

$$C' = C - a \times \sin(\beta) \text{ where,}$$

C' = Clearance at bow flare

C = Clearance due to bow radius and fender deflection

a = Height from fender to ship deck

(or to top of structure, whichever is lower)

β = Bow flare angle



Always check the clearance between the fender panel or brackets and structure too.

ODD FENDER CONTACT (1, 3, 5 ETC.)

- ▶ Energy absorbed by one fender plus the fenders on each side
- ▶ Larger middle fender deflection is likely
- ▶ Bow flare is important
- ▶ Single fender contact likely for smallest ships
- ▶ Multiple fender contact possible with biggest ships

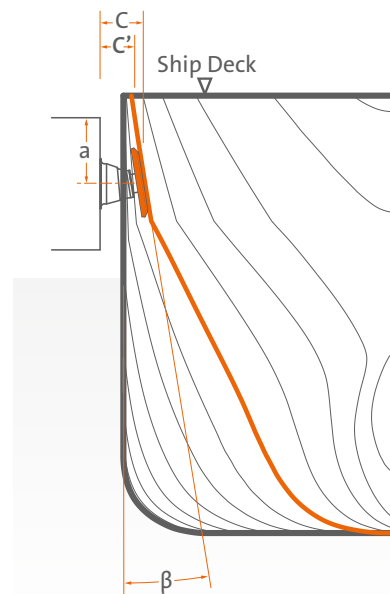

DOLPHINS & END FENDERS

On dolphin structures and for the end fenders on continuous berths, it is common to design with a fender compression angle the same as the ship's berthing angle ($\Theta = \alpha$).

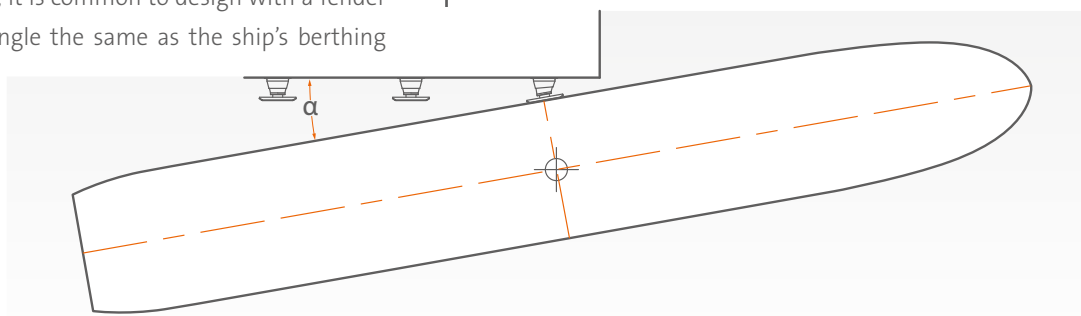

BENDING MOMENTS

Fender panels are designed to distribute forces into the ship's hull. Ships usually contact the fender panel at one or two points or as a flat hull contact. This creates bending moments and shear forces in the panel structure. Bending moments and shear forces are estimated using simple static methods. A more detailed analysis is needed to study the complicated effects of asymmetric load cases. Special care is needed where stresses are concentrated such as chain brackets and bolted connections. ShibataFenderTeam is equipped to assist with advanced structural analysis in compliance with European, American and other design codes.

DESIGN CASES

Some simplified common design cases are given below:

MIDDLE BELTING CONTACT

A ship belting contacting the middle of the panel will cause high bending moments. The upper and lower fenders are equally compressed and can both reach peak reaction.

$$L = 2a$$

$$F = 2R_f$$

$$V(x = a) = R_f$$

$$M(x = a) = F \times L / 4$$

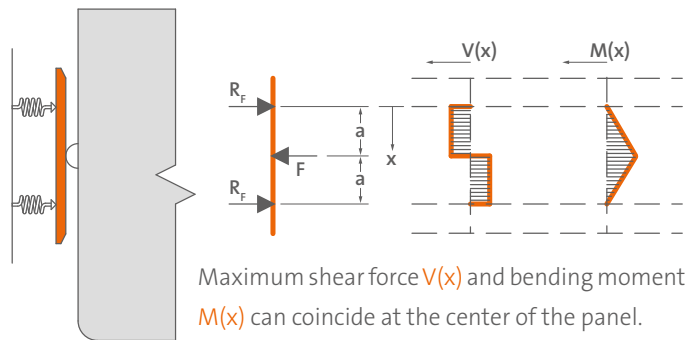

LOW BELTING CONTACT

Low belting contacts cause the panel to tilt with unequal deflection of fenders. The top may contact the ship hull, creating a long length of panel which must resist bending.

$$L = 2a + b$$

$$F = R_f$$

$$V(x = a) = F$$

$$M(x = a) = F \times a$$

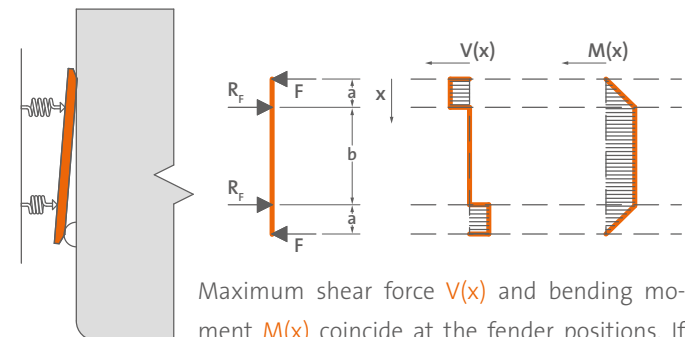

FLAT HULL CONTACT

High freeboard ships with flat sides may contact the full fender panel. Systems may have one or more rubber units which will be equally compressed.

$$L = 2a + b$$

$$q = 2R_f / L$$

$$V(x = a) = q \times a$$

$$M(x = a) = q \times a^2 / 2$$

$$M(x = L/2) = M(x = a) - q \times b^2 / 8$$

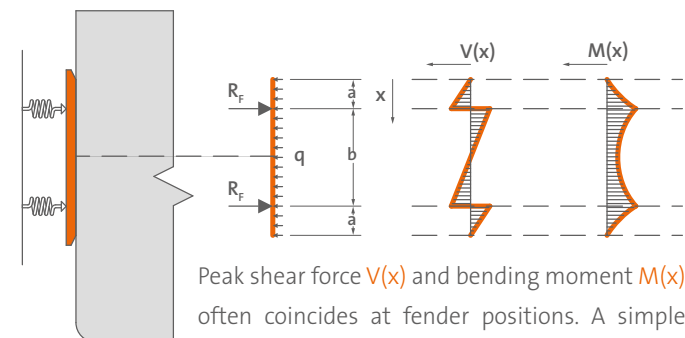

PANEL CONSTRUCTION

Most modern fender panels use a “closed box” construction. This method of design has a high strength to weight ratio and creates a simple exterior shape which is easier to paint and maintain. The inside of the panel is pressure tested to confirm it is fully sealed from the environment and water ingress.

A typical fender panel cross-section includes several vertical stiffeners, usually channels or T-sections fabricated from steel plate. The external plate thicknesses, size and type of stiffeners will depend on many factors. ShibataFenderTeam engineers will advise on the best design for each case.

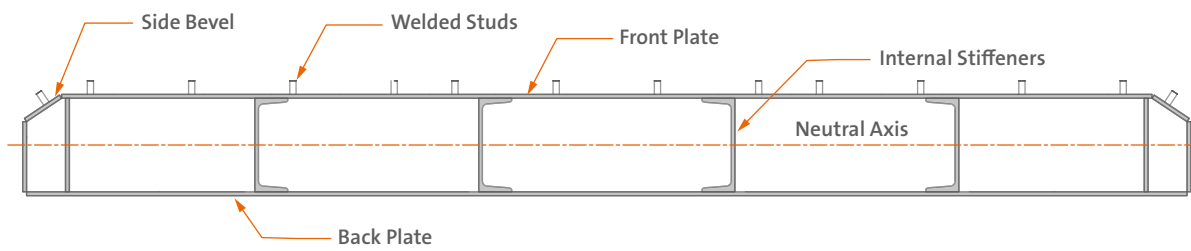

There are many demands on the fender panel which cause bending, shear, torsion, crushing and fatigue.

The marine environment demands good paint coatings which prevent steel from corroding and to maintain panel strength.

Low temperatures require special steel grades which do not become brittle.

Face pads must be secured to the panel firmly, but still allow easy replacement during the lifetime of the fender.

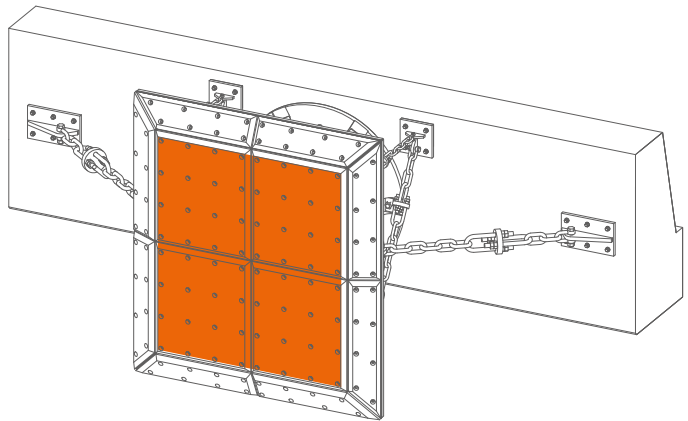

FENDER PANELS

STEEL THICKNESS

PIANC 2002 recommends minimum steel thicknesses for panel construction. Sections will often be thicker than the required minimum for heavy and extreme duty systems.

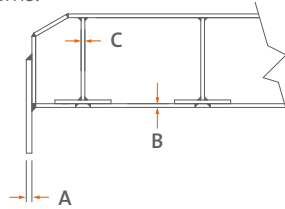

A	Exposed both sides	≥ 12 mm (1/2")
B	Exposed one side	≥ 9 mm (3/8")
C	Internal (not exposed)	≥ 8 mm (5/16")

STEEL GRADES

Fender panels are made from weldable structural steels. The grade used may depend on local conditions and availability. Some typical steel grades are given below.

COMMON EUROPEAN GRADES				COMMON AMERICAN GRADES			
EN10025	Yield N/mm ²	Tensile N/mm ²	Temp °C	ASTM	Yield N/mm ²	Tensile N/mm ²	Temp °C
S235JR	235	360	N/A	A36	250	400	*
S275JR	275	420	N/A	A572-42	290	414	*
S355J2	355	510	-20	A572-50	345	448	*
S355J0	355	510	0	*ASTM steel grades for low temperature applications should specify required charpy value and test temperature.			

FENDER PANEL WEIGHTS

Every fender design is different, but this table may be used as a rule of thumb for initial calculations of other components like chains.

Standard duty panels: 200–300 kg/m² **Heavy duty panels:** 300–400 kg/m² **Extreme duty panels:** Over 400 kg/m²

HULL PRESSURES

Many ships can resist limited pressure on their hull, so it is important to determine the likely fender contact pressure according to the ship freeboard and tides to ensure allowable limits are not exceeded.

In the absence of more specific information, the PIANC guidelines below are commonly used.

CLASS	SIZE	PRESSURE kN/m ² (kPa)
Oil tankers	Handysize	≤ 300
	Handymax	≤ 300
	Panamax or bigger	≤ 350
	VLCC	150–200
Bulk carriers	All sizes	≤ 200
Container	Feeder	≤ 400
	Panamax	≤ 300
	Post-Panamax	≤ 250
	ULCS	≤ 200
General Cargo	≤ 20,000 DWT	400–700
	> 20,000 DWT	≤ 400
RoRo & Ferries	Not applicable – usually belted	

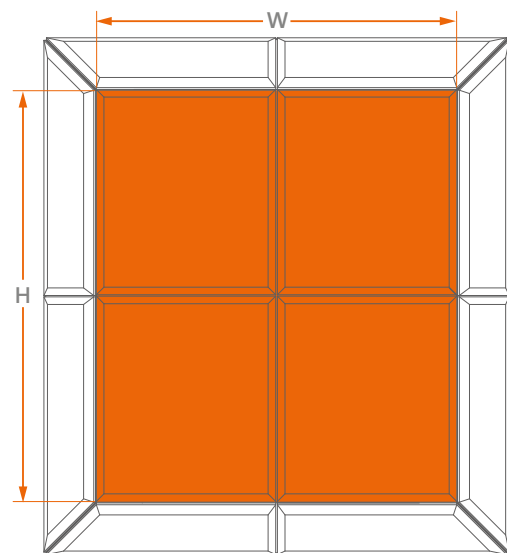

- \bar{HP} = Average hull pressure (kN/m² or kPa)
- ΣR_f = Total fender reaction (kN)
- W = Width of flat panel (m)
- H = Height of flat panel (m)
- A = Contact area of flat panel (m²)

PRESSURE DISTRIBUTION

Hull pressure is distributed evenly if the fender reaction into the panel is symmetrical. When the fender reaction is off-center the peak hull pressure is greater, even though average hull pressure remains the same. The examples below show typical design cases. It is common to use a fender arrangement so that maximum hull pressure is no more than double the average hull pressure.

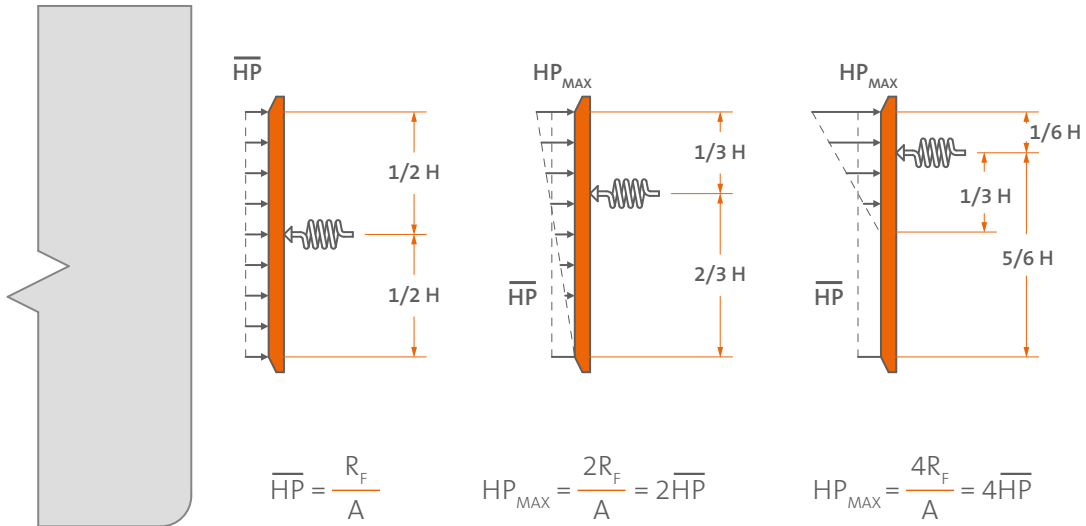

LOW FRICTION PADS

Ultra-high Molecular Weight Polyethylene (UHMW-PE) pads are replaceable facings fitted to fender panels. Good wear resistance with a low-friction surface helps prevent damage to ship hulls and paintwork. They also reduce shear forces in fender chains.

Large UHMW-PE sheets are sinter moulded from polymer granules. These can then be planed (skived), cut to size, drilled and chamfered to create individual pads. These are attached to the panel with welded studs, bolts or low profile fixings.

UHMW-PE is available in virgin and reclaimed grades, many colours and thicknesses to suit standard, heavy duty and extreme applications.

Materials		Friction Coefficient (μ)	
Material 'A'	Material 'B'	Minimum	Design*
UHMW-PE	Steel (wet)	0.1–0.15	≥ 0.2
UHMW-PE	Steel (dry)	0.15–0.2	≥ 0.2
HD-PE	Steel	0.2–0.25	≥ 0.3
Rubber	Steel	0.5–0.8	≥ 0.8
Timber	Steel	0.3–0.5	≥ 0.6

*A higher design value is recommended to account for other factors such as surface roughness, temperature and contact pressure which can affect the friction coefficient.

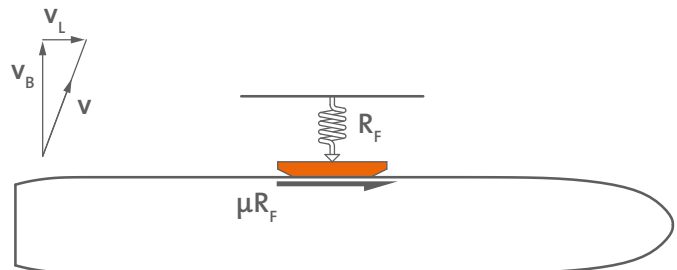

Friction is important to good fender design. Ships will inevitably move against the fender face, generating forces which can alter the fender deflection geometry. With reduced friction and proper chain design, these effects are minimised.

LOW FRICTION PADS

Pads selection and fixing method should consider factors including impact, wear or abrasion caused by beltings, swell and frequency of use. If access is difficult then extra wear allowance may be useful to reduce maintenance and full life costs.

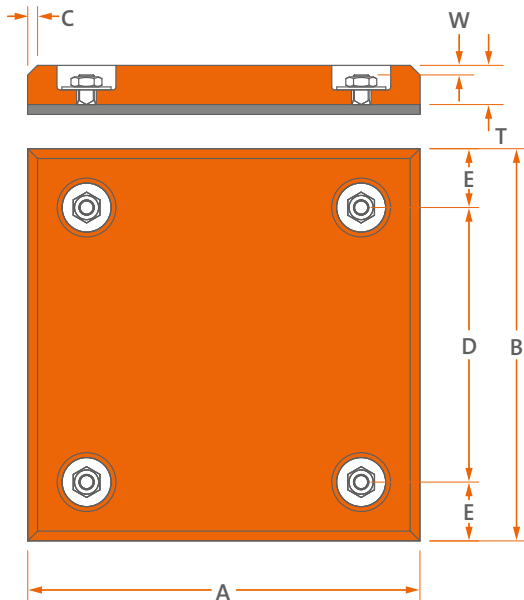

Pad (T) [mm]	Weight [kg/m ²]	Fixing Size	Wear (W)* [mm]
30*	28.5	M16	5
40*	38.0	M16	10
50	47.5	M20	15

* For Flange Nut Fixing

Layout	[mm]
Edge chamfer (C)	15
Bolt spacing (D)	300 – 400
Edge distance (E)	> 70

Other dimensions upon request.

PAD FIXINGS

UHMW-PE face pads are attached in various ways according to the type of panel. Studs or bolts with blind nuts are commonly used for closed box panels. Standard nuts are used for open panels and structures. Flange Nut Fixings can provide a greater wear allowance. Larger washers are required to spread loads and prevent pull through. The thickness of PE under the head of the washer is usually 25–35% of the pad thickness.

Stud / Flange Nut Fixing

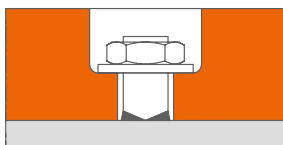

Bolt with Blind Nut

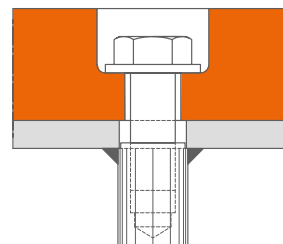

COLOURED PADS

UHMW-PE pads come in many different colours to allow for greater visibility or easy differentiation between berths. Common colours are black, white, grey, yellow, blue and green.

SMALL OR LARGE PADS

Larger pads have more fixings and might be more durable. Small pads are lighter, easier to replace and less expensive. In some countries the maximum lifting weight (often 25 kg) can dictate biggest pad size.

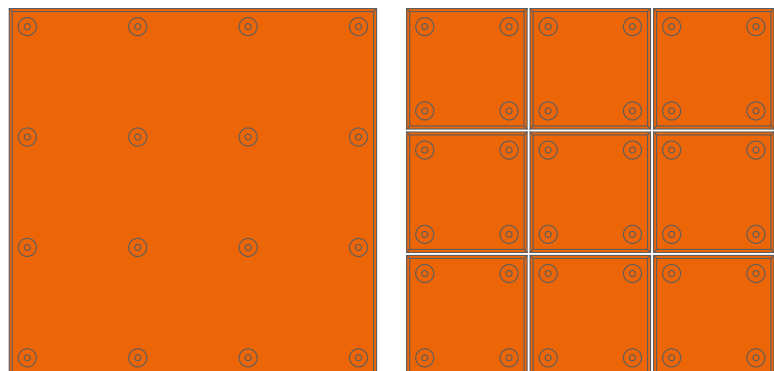

CHAIN DESIGN

Chains are used to control the geometry of the fender during impact and to prevent excessive panel movements. They can assist to support the weight of large panels, to prevent droop or sagging, and to increase rubber deflections and energy absorption in low-blow impact cases.

- ▶ Shear chains are used to limit horizontal movement.
- ▶ Weight chains will limit vertical movement and reduce droop or sag.
- ▶ Tension chains work in conjunction with weight chains to limit droop, can also improve performance during low-blow impacts.
- ▶ Chain brackets can be anchored, bolted, welded or cast into the structure.
- ▶ Tensioners limit the slack in chains due to tolerances or wear.

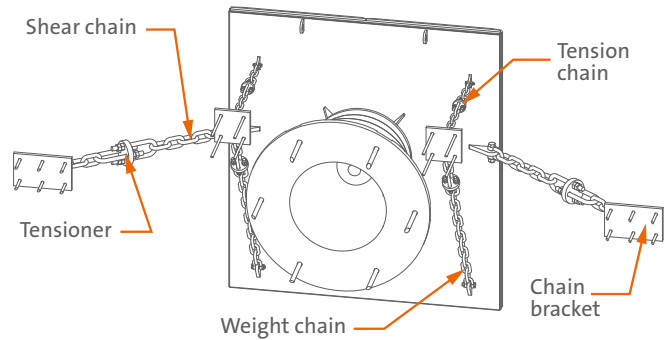

The length (L) and static angle (α_0) are the most important factors determining the load and size of chains.

T = Working load per chain assembly (kN)

R_f = Fender system reaction (kN)

μ = Friction coefficient

G = Weight of fender panel, PE pads etc. (kN)

L = Length of chain pin-to-pin (m)

Δ = Fender deflection (m)

n = Number of chains acting together

α_0 = Static angle of chain(s), fender undeflected (deg.)

α_1 = Dynamic angle of chain(s), fender deflected (deg.)

x = Panel movement due to chain arc (m)

$$\alpha_1 = \sin^{-1} \left[\frac{(L \times \sin \alpha_0) - \Delta}{L} \right]$$

$$x = L \times (\cos \alpha_1 - \cos \alpha_0)$$

$$T = \frac{G + \mu \times R_f}{n \times \cos \alpha_1}$$

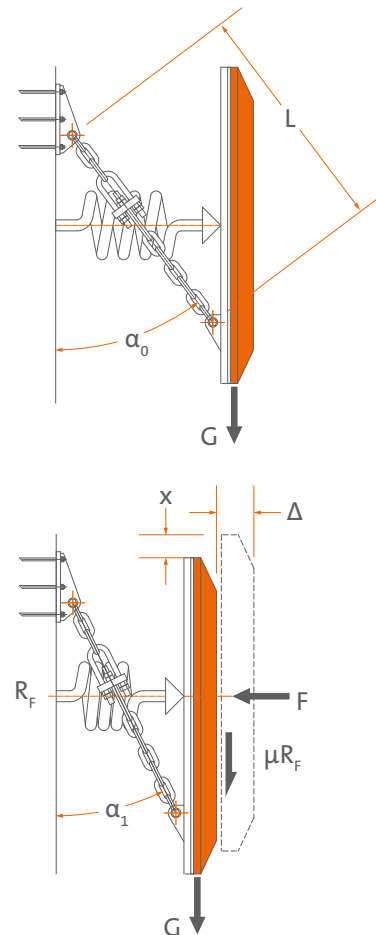

DESIGN NOTES

- (1) Highest chain loads often occur when the fender unit reaches a peak reaction at about half the rated deflection.
- (2) For shear chains, G = 0
- (3) ShibataFenderTeam recommends a safety factor (η) of 2 for most applications, but a larger factor can be used on request.
- (4) An easy to replace and inexpensive weak link or element should be included in the chain assembly to avoid overload damage to fender panel or structure.

CHAIN DROOP

Chains are sometime specified to have “zero” slack or droop, but this is unrealistic and unnecessary. Even a very small slack ($S-a$) of around 2% of the chain length (S) will cause the chain to “droop” in the center (h) by almost 9% of chain length.

For example, a 2,000 mm long chain with 40 mm of slack will droop in the middle by over 170 mm. The same chain with just 7 mm of slack will still droop by about 50 mm.

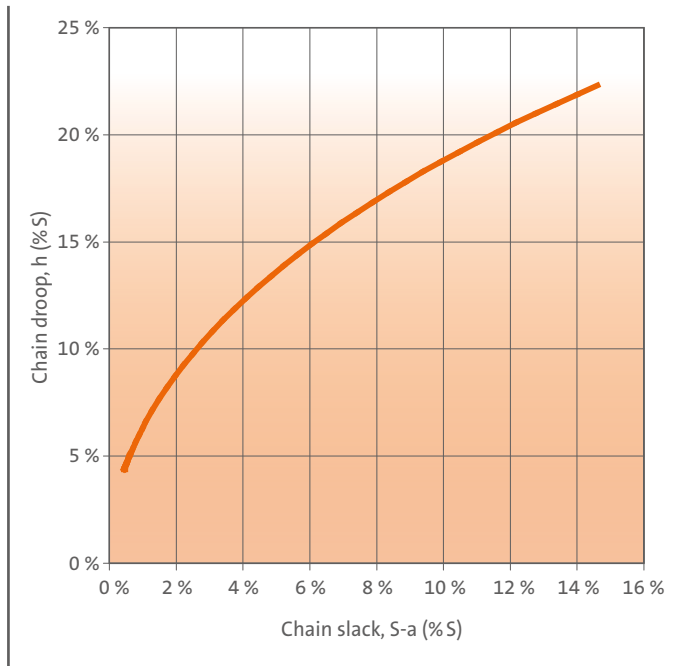
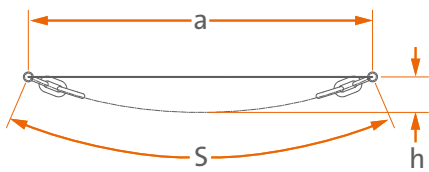

BRACKET DESIGN

Chain brackets can be designed to suit new or existing structures, steel or concrete. The bracket should be considerably stronger than the weakest component of the chain assembly. Their design must allow the chain to freely rotate through its full arc and should not interfere with other brackets, the fender panel or rubber fender body during compression. The main lug should be sufficiently thick or include spacer plates to properly support the correct size and type of shackle. The weld size holding the bracket lug to the base plate is critical and should be referred to ShibataFenderTeam engineers for detail design. Also size, grade and positions of anchors or securing bolts should be assessed at the detail design phase.

SINGLE

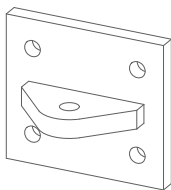

DOUBLE

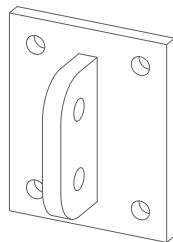

TWO PLANE

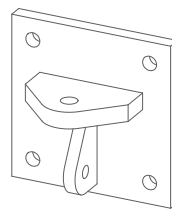

TWIN PADEYE

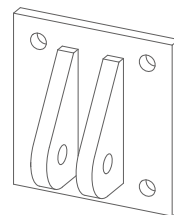

CAST-IN DOUBLE

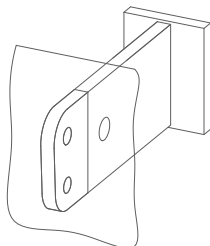

CAST-IN U ANCHOR

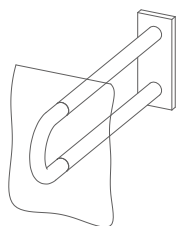

Please refer to ShibataFenderTeam for advice on suitable bracket type and size, material and finish of chain brackets.

WHEEL & ROLLER FENDERS

Wheel Fenders have a sliding axle and rollers to increase deflection and energy, so they are suitable for lock entrances and vulnerable berth corners.

Roller Fenders have a fixed axle to allow almost zero resistance rotation, suitable for guiding ships within locks and dry docks.

WHEEL FENDER

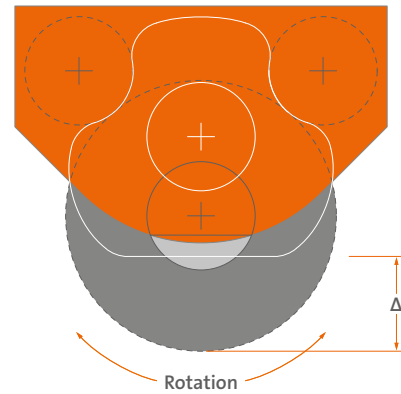

ROLLER FENDER

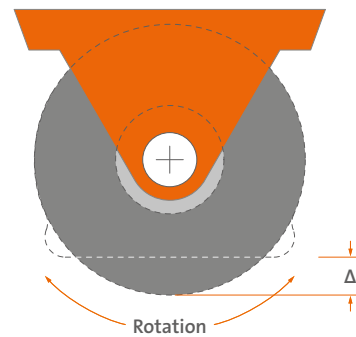

During lock and dry dock approach the ship is nearly parallel to the lock wall, but can be closer to one side. The bow contacts the Wheel Fender which deflects the ship. As the ship continues to enter, the Roller Fenders act as a guide to protect the hull and lock wall.

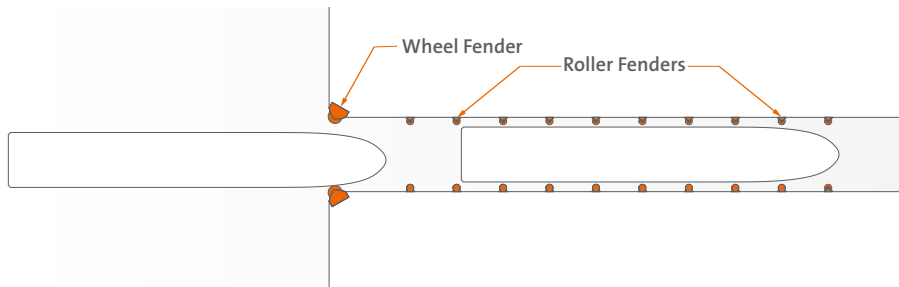

Some conventional berths have exposed corners which need to be protected by a Wheel Fender. Although the ship can be at a large angle to the main fenders, the effective berthing line on the Wheel Fenders remains at 0°. In many cases midships impact should be considered.

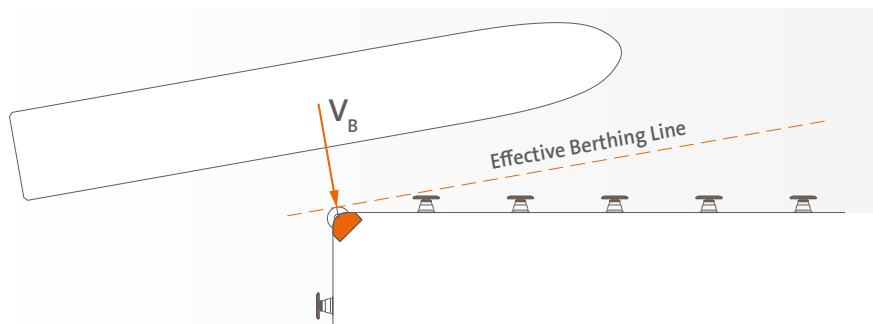

SPECIAL IMPACT CASE

If the ship is moving into the lock or dry dock, an impact with Wheel Fender can occur on the bow section. The effective berthing line is the tangent to the bow.

For energy calculations, the component of velocity perpendicular to the berthing line is required:

$$V_B = V \times \sin \Theta$$

α = Drift angle of ship (true course)

Such manoeuvres are difficult and ship forward speed is quite low. Typical design values are:

$$V \leq 1 \text{ m/s}$$

$$\alpha \leq 10^\circ$$

$$\Theta \leq 5^\circ$$

$$V_B < 1.0 \times \sin (5^\circ + 10^\circ) = 0.26 \text{ m/s}$$

The angle of the effective berthing line is larger for impacts closer to the bow, but the distance from center of mass to point of impact (R) also increases. The value of the Eccentricity Factor (C_e) needs careful consideration. Refer to ShibataFenderTeam for advice.

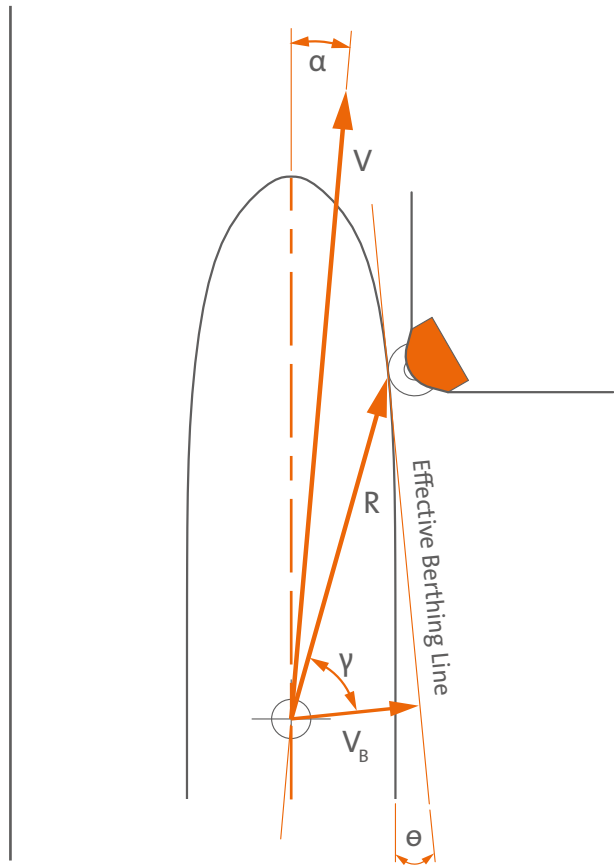

For best performance, Wheel Fenders should be oriented according to the expected angle of the ship.

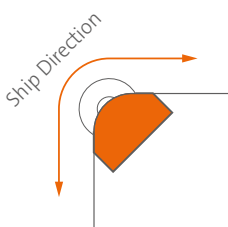

45° to each berth

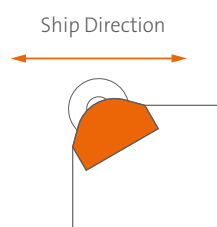

0-30° from main berthing line

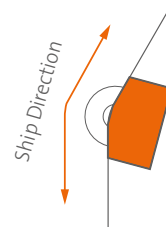

Equally offset from each berth

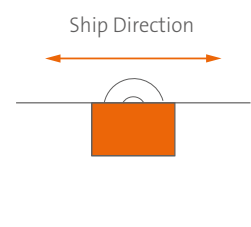

Parallel to ship direction

Single Wheel Fenders are used where there is small variation in water level. Multiple or “stacked” Wheel Fenders are used for large tides or water level changes.

SINGLE WHEEL

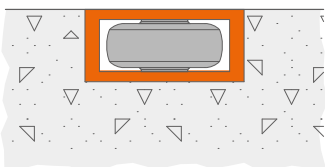

DOUBLE WHEEL

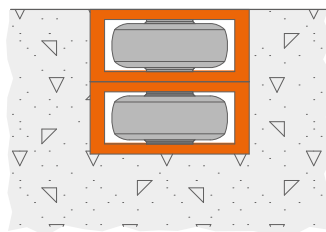

TRIPLE WHEEL

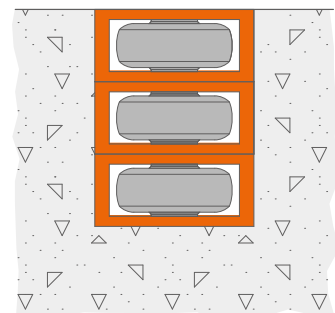



FOAM FENDER DESIGN

Foam Fenders come in many configurations. Ocean Guard Fenders and Ocean Cushion Fenders can be used floating or suspended from the dock. Donut Fenders are pile supported, rising and falling with the tide. Foam Fenders have a number of unique characteristics which must be considered during design. These include ambient temperature, compression angle and number of cycles.

FOAM GRADES & CYCLES

The foam core is a closed cell cross-linked polyethylene which is comprised of many millions of small air pockets. Softer foam grades have larger air pockets and a lower density. Harder foams have smaller air pockets and a higher density. After multiple compressions the stiffness of the foam reduces due to stress relaxation. The “datum” performance of Foam Fenders is considered after the third compression cycle.

FOAM GRADE		NUMBER OF COMPRESSION CYCLES (n)										
		1	2	3	4	5	6	7	8	9	10	100
Low Reaction	LR	1.30	1.07	1.00	0.97	0.95	0.94	0.93	0.92	0.92	0.91	0.88
Standard	STD	1.31	1.07	1.00	0.97	0.95	0.94	0.93	0.92	0.92	0.91	0.88
High Capacity	HC	1.40	1.09	1.00	0.96	0.94	0.92	0.91	0.90	0.89	0.89	0.85
Extra High Capacity	EHC	1.45	1.10	1.00	0.95	0.93	0.91	0.90	0.89	0.88	0.88	0.83
Super High Capacity	SHC	1.54	1.11	1.00	0.95	0.92	0.90	0.88	0.87	0.87	0.86	0.81

The reduced stiffness of the fender after multiple compressions is typically compensated by the higher performance at higher rates of compression due to the conservative rating of the fender performance at 60% compression. This has been demonstrated by independent laboratory testing of our Foam Fenders in which the rated performance was reached well below the rated deflection. Consequently, Foam Fender designs should be based on 3rd compression values, i.e. catalogue performance values.

VERTICAL COMPRESSION

A vertical compression angle may occur due to bow flare or roll of the ship.

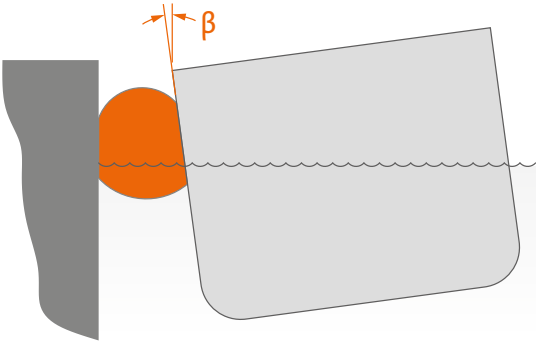

LONGITUDINAL COMPRESSION

A longitudinal compression angle may occur due to angular berthing or bow curvature.

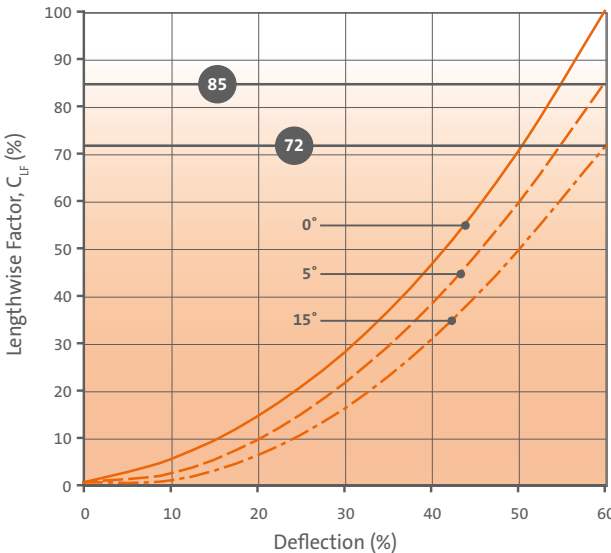
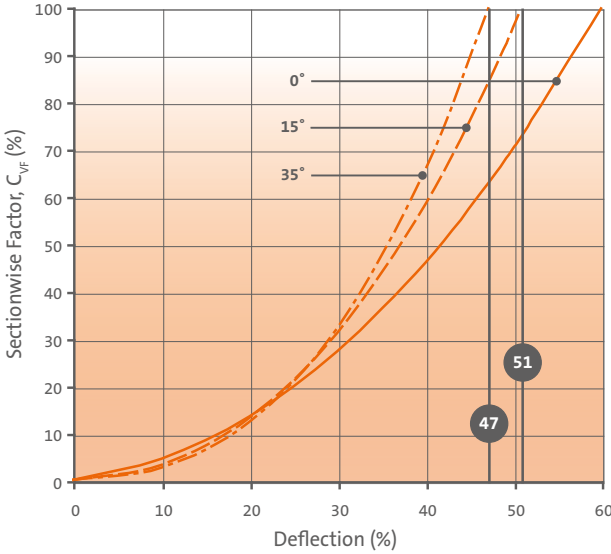
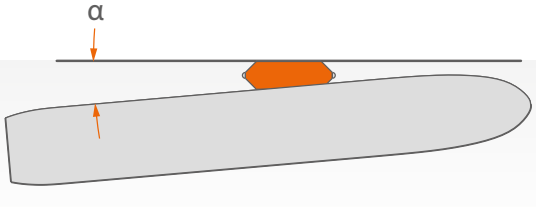

FOAM FENDER INSTALLATION

Foam Fenders can float with the tide or be secured above water level. The choice of mooring method depends on several factors:

- ▶ Tidal range at the site
- ▶ Likely compression angles
- ▶ Lengthwise or vertical motion of berthing and moored ships
- ▶ Available footprint area on structure
- ▶ Abrasiveness of structure face
- ▶ Flatness of the structure face (i.e. sheet piles)
- ▶ Significant wave height relative to fender size
- ▶ Accessibility for maintenance

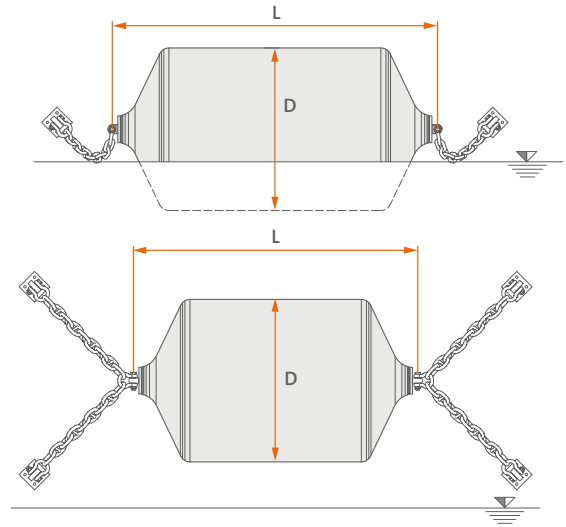

FENDER FOOTPRINT

The structure height and width must be sufficient to allow the Ocean Guard Fender to freely expand as the body is compressed. Total mounting area dimensions should allow for rise and fall of the fender, also any movement permitted by slack in the chains.

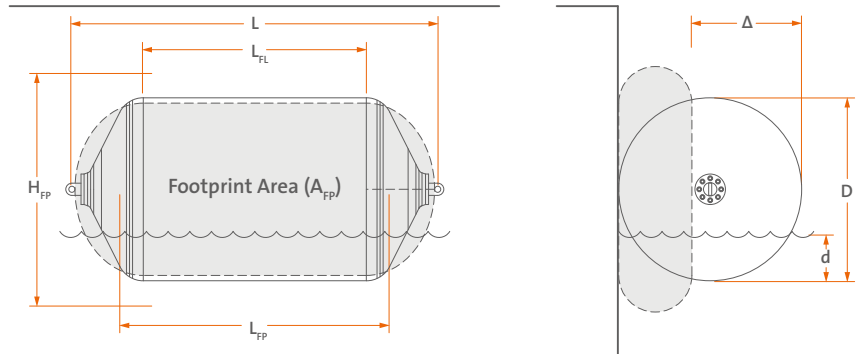

WATER DRAFT

Ocean Guard draft varies according to the foam density used, its skin thickness, the size and length of chains and anything that may reduce or increase the fender weight. The table provides typical values for LR, STD and HC grades. Ask ShibataFenderTeam about other design cases.

DIAMETER (D) x LENGTH (L)	SKIN [mm]	FLAT LENGTH L _{FL} [mm]	FOOTPRINT HEIGHT H _{FP} [mm]	FOOTPRINT LENGTH L _{FP} [mm]	FOOTPRINT AREA A _{FP} [sqm]	WEIGHT STD [kg]	END PULL SWL [kN]	WATER DRAFT (d)		
								LR [mm]	STD [mm]	HC [mm]
700 x 1,500	19	880	660	1,460	0.87	109	42	210	250	290
1,000 x 1,500	19	700	940	1,460	1.19	147	42	250	310	370
1,000 x 2,000	19	1,190	940	1,950	1.66	200	42	200	270	330
1,200 x 2,000	19	980	1,130	1,940	1.93	299	76	310	380	450
1,500 x 3,000	25	1,830	1,410	2,950	3.77	653	107	280	380	470
1,700 x 3,000	25	1,710	1,600	2,930	4.18	748	107	310	420	520
2,000 x 3,500	25	2,070	1,880	3,430	5.78	1,161	151	330	470	590
2,000 x 4,000	29	2,560	1,880	3,920	6.70	1,397	151	320	460	580
2,000 x 4,500	29	3,050	1,880	4,430	7.66	1,571	222	300	440	560
2,500 x 4,000	32	2,230	2,360	3,910	8.14	1,925	311	400	580	730
2,500 x 5,500	38	3,660	2,360	5,400	11.64	3,095	311	390	570	720
3,000 x 4,900	38	2,770	2,830	4,790	12.00	3,295	311	460	670	850
3,000 x 6,000	38	3,900	2,830	5,900	15.15	4,370	489	430	640	830
3,300 x 4,500	38	2,230	3,110	4,390	11.82	3,531	489	560	790	990
3,300 x 6,500	41	4,240	3,110	6,380	18.02	5,485	489	440	680	890

FOAM FENDER INSTALLATION

A) SUSPENDED MOORING

When fully suspended above water, the dock height must be greater than the fender footprint plus any movement allowed by chains. An uplift chain is fitted to prevent the fender from being lifted or rolled onto the top of the dock as tide or ship draft changes.

B) SIMPLE FLOATING MOORING

A simple floating mooring needs chains that are long enough at highest and lowest tides plus some extra slack to prevent 'snatch' loads in the chains and end fittings of the fender. Lateral fender movement at mid tide should be considered in the design.

C) FLOATING GUIDE RAIL

A more robust mooring for high tide areas uses a guide rail. The chain connects to a mooring ring or roller around the rail. This arrangement keeps the chain loads uniform, limits sideways motion and is the best solution for tidal areas.

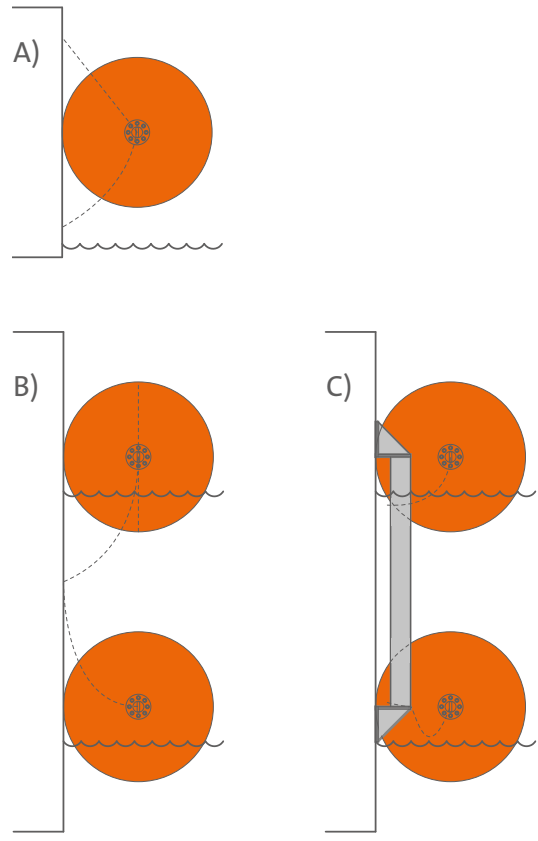

REDUCING ABRASION

Skin abrasion can occur if the Ocean Guard Fender is mounted directly against a concrete dock or other rough surface. The rate of wear can be higher if there are waves or currents which cause the fender to continuously move. Wear can be reduced or eliminated by fitting a series of UHMW-PE strips in the reaction area. Other materials like timber can also be used but will require extra maintenance.

Mounting directly to concrete promotes wear

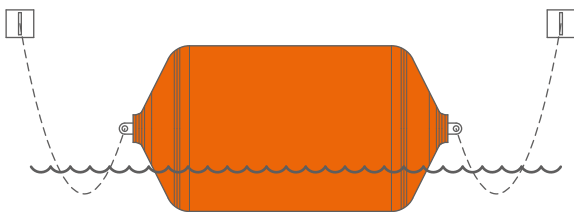

UHMW-PE strips will extend service life

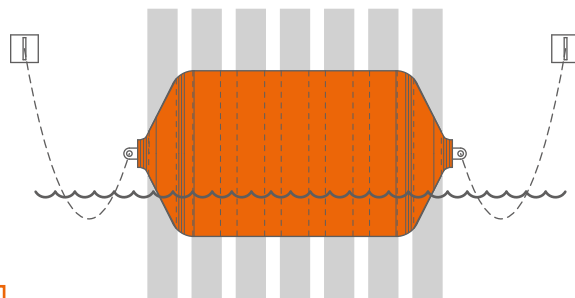

Floating fenders will move continuously due to wind, waves, tide and currents. Over time the shackles can vibrate loose (even with bolt pin). Regular mooring inspections are advised, but to reduce the risk of fenders detaching, shackles should use a locking nut or the nut should be tack welded to the shackle body.

Shackle with locknut

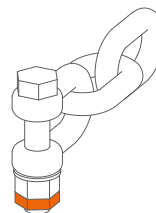

Shackle with tack weld

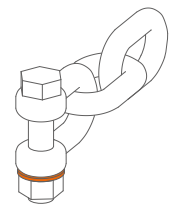

DONUT FENDERS

Donut Fenders absorb energy by compressing the foam annulus and, in most cases, by elastic deflection of the tubular steel pile. They are commonly used in high tidal zones, to provide training walls for locks and to protect vulnerable dock corners.

The Donut Fender floats up and down the pile with the tide, so designs need to consider several cases to achieve the desired performance at all times. Each of the variables listed below will affect the fender performance:

- ▶ Foam density (grade)
- ▶ Donut Fender inside and outside diameters
- ▶ Donut Fender height
- ▶ Tidal range
- ▶ Pile diameter and wall thickness
- ▶ Pile free length from fixity
- ▶ Loss of pile thickness over time due to corrosion

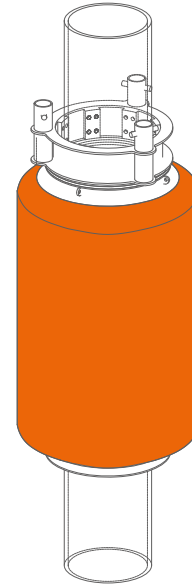
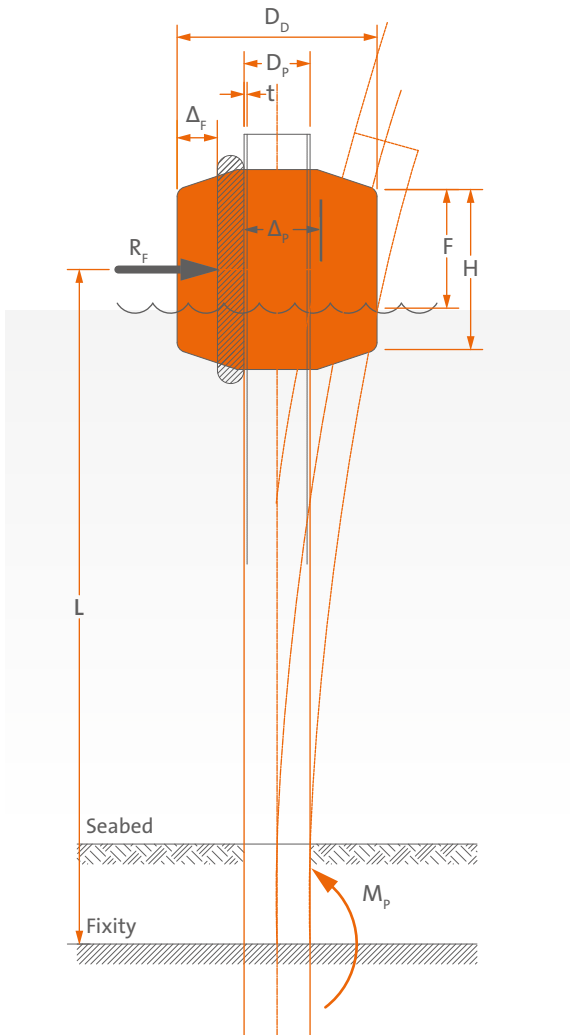

FREEBOARD

The freeboard (in millimeters) can be estimated for common Donut Fender sizes and STD grade foam:

$$H = 0.75 \times D_o \rightarrow F = 0.963 \times H - 720$$

$$H = 1.00 \times D_o \rightarrow F = 0.946 \times H - 810$$

$$H = 1.25 \times D_o \rightarrow F = 0.938 \times H - 910$$

$$H = 1.50 \times D_o \rightarrow F = 0.929 \times H - 990$$

For other sizes and foam grades, ask ShibataFenderTeam

PILE DEFLECTIONS

As the Donut wall is compressed, the reaction force (R_f) will deflect the pile. Assuming a built-in end at fixity the pile deflection, stiffness and energy can be estimated:

Pile Moment: $M_p = R_f \times L$

2nd Moment of Area: $I_{xx} = [D_p^4 - (D_p - 2t)^4]$

Young's Modulus: $E = 200 \times 10^9 \text{ N/mm}^2$

Pile Deflection: $\Delta_p = \frac{R_f \times L^3}{3 \times E \times I_{xx}}$

Maximum Pile Stress: $\sigma = \frac{M_p}{Z_{xx}}$

Pile Energy: $E_p = 0.5 \times R_f \times \Delta_p$

DONUT & PILE ENERGY

The total energy absorbed by the pile and the Donut Fender is estimated as follows:

Total Energy: $\Sigma E = E_f + E_p$

DONUT FENDER APPLICATIONS

Donut Fenders commonly protect corners or assist in guiding ships onto berths and into locks.

Single or multiple Donut Fenders are commonly used to protect exposed berth corners.

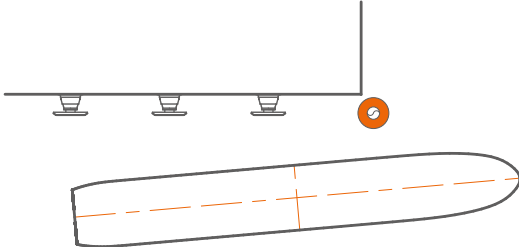

Where ships move forward or astern against fenders, a Donut Fender will reduce friction and shear forces. Donut Fenders can be an economic solution for RoRo berths.

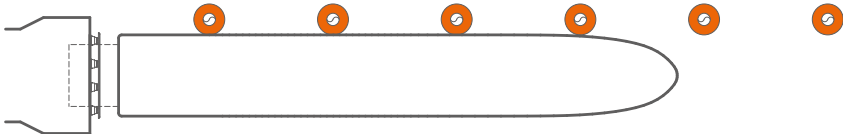

Ships approaching locks and drydocks need “training” to align themselves. Donut Fenders help to guide ships into narrow entrances.

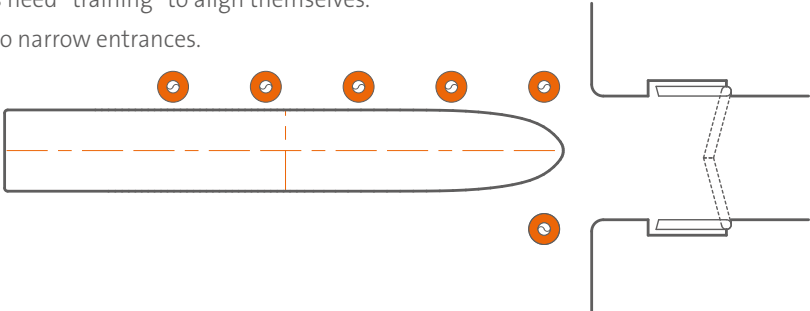

PNEUMATIC FENDER INSTALLATION

Pneumatic Fenders are normally allowed to float, rising and falling with the tide. It is important to allow sufficient area on the dolphin or dock for the Pneumatic Fender to properly compress without risk of coming onto the deck or moving off the side of the structure.

It is also important to use the correct size, length and grade of chain with corresponding shackles and swivels. Shackles should be locked or tack welded to avoid loosening. It is possible to hang some Pneumatic Fenders from the dock wall, but not all types and sizes are suitable for this and fender ends require special reinforcement. ShibataFenderTeam can advise on all applications.

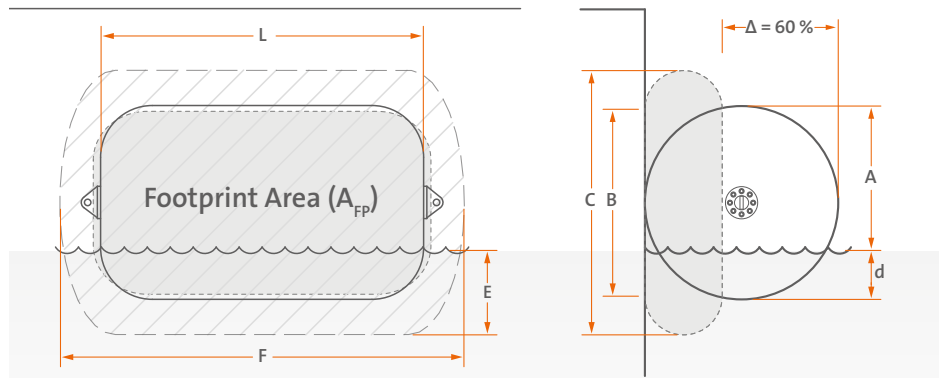

SIZE (D X L)	A	B	C	d	E	F	CHAIN [mm]
φ 1,000 x 1,500 L	769	942	1,342	231	431	1,575	16
φ 1,200 x 2,000 L	949	1,130	1,610	251	491	2,100	18
φ 1,500 x 2,500 L	1,194	1,413	2,013	306	606	2,625	22
φ 2,000 x 3,500 L	1,639	1,884	2,684	361	761	3,675	28
φ 2,500 x 4,000 L	2,111	2,355	3,355	389	889	4,200	32
φ 3,300 x 6,500 L	2,698	3,109	4,429	602	1,262	6,825	44
φ 4,500 x 9,000 L	3,670	4,239	6,039	830	1,730	9,450	50

Dimensions given are for chain & tire net fenders, 50 kPa initial pressure. For all other cases ask ShibataFenderTeam for advice.

SHIP-TO-SHIP BERTHING

Ship-to-ship berthing (lightering) requires special planning in every case. Consideration must be given to the impact energy and approach angles as well as to the relative motions of ships, especially any rolling which might bring hulls close together. The fender size must be selected to maintain a safe distance apart, but not so large that the fenders could roll onto the deck of smaller ships with low freeboard.

Fenders moored individually

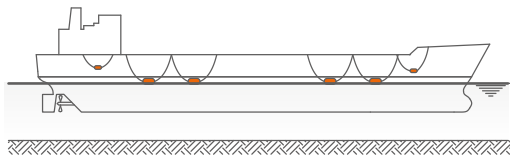

Fenders connected together in a "trot"

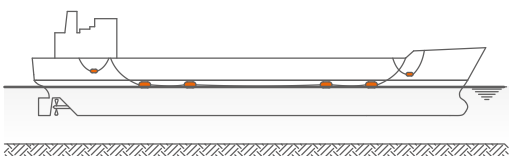

Ship sizes and fender layout must be carefully pre-planned for ship-to-ship berthing.

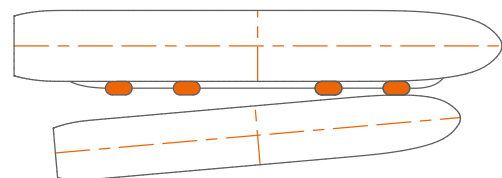

HYDROPNEUMATIC FENDERS

There are several vessel types with most of their hull below waterline, including submarines and semi-submersible oil platforms. Submarines in particular have very sensitive hulls with acoustic rubber tiles and demand a gentle, conforming fender.

Hydropneumatic Fenders are part filled with water and use a ballast weight to remain vertical in the water. A backing frame or flat dock construction is needed to support the fender, as well as mooring lines to prevent it drifting away from its position.

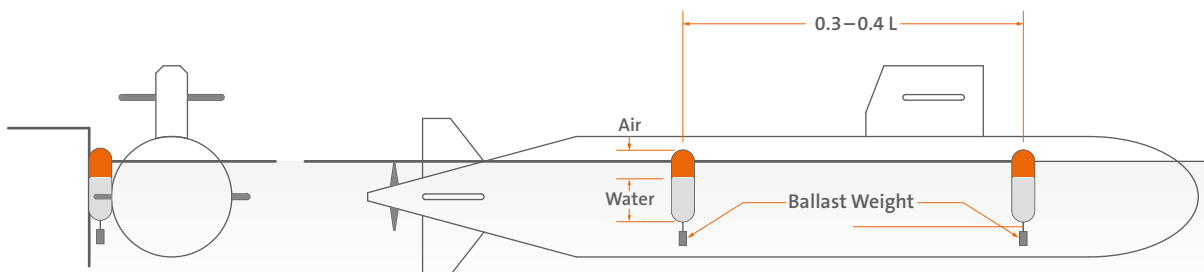
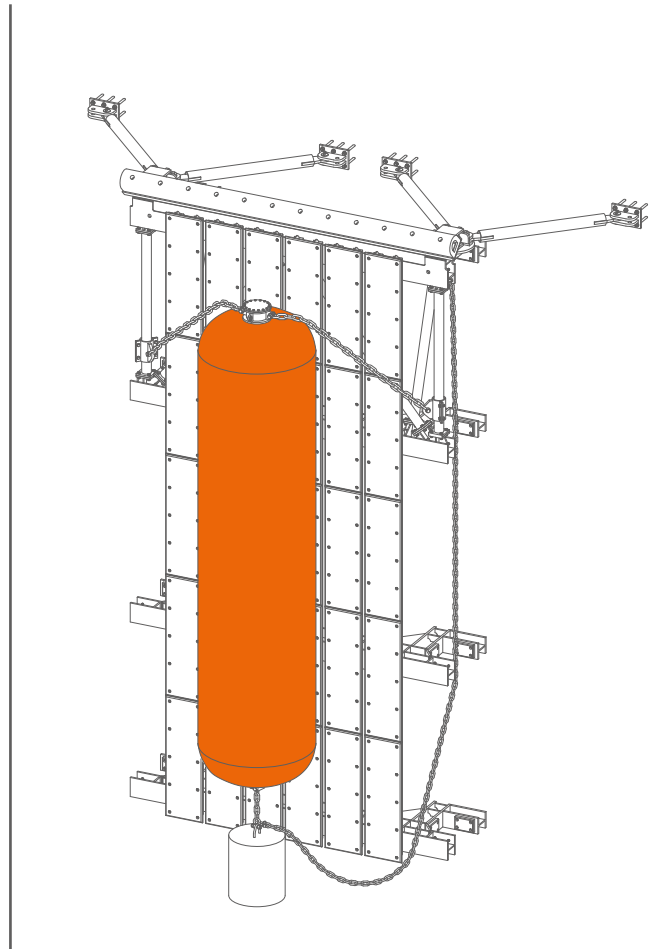

Hydropneumatic Fender performance can be adjusted to suit different classes of vessel. This is done by changing the air:water ratio as well as adjusting internal pressure. The draft of the fender can be changed by using different ballast weights to ensure the fender body makes contact with the widest beam part of the vessel. With submarines it is also important to avoid hydroplane contact.

ENVIRONMENT

The harsh marine environment puts many demands on fender systems. A high priority should be given to reliability, durability and resistance to degradation according to local conditions.

EFFECT	COMMENTS	TROPICAL/ SUBTROPICAL	TEMPERATE	ARCTIC/ SUBARCTIC
Corrosivity	High temperatures may accelerate corrosion, as can high salt concentrations in some tropical/subtropical zones. Designs must use appropriate paint coatings, stainless steel fixings where necessary and consider corrosion allowances on plate thicknesses and chain link diameters to minimize maintenance.	High	Moderate	Moderate
Ozone & Ultra Violet Light (UV)	Over time, ozone causes surface embrittlement of rubber and ultra violet causes cracking. The effects are mitigated by good materials and compounding, but cannot be eliminated.	High	Moderate	High
Fatigue	Fatigue may arise anywhere and should be considered in designs. In low temperatures the effects of fatigue loads can be more serious if selected materials become brittle.	Varies	Varies	High
Thermal effects	High temperatures cause rubber to become softer, reducing energy absorption. Low temperatures have the opposite effect and increase reaction forces. Steel and plastic grades for very low temperatures need consideration to avoid becoming brittle.	High	Moderate	High
Motion & vibration	Vibration and large ship motions can occur in any zone, but commonly on exposed berths and deepwater terminals. Designs should consider the effects of motion and vibration on face pad abrasion, loosening of fixings and wear of chain assemblies.	Varies	Varies	Varies

CORROSION PREVENTION

There are several effective ways to prevent or reduce corrosion of fender panels and accessories.

GALVANIZING

Galvanizing is the application of a protective zinc coating to steel which prevents rusting as the zinc 'layer' corrodes in preference to the steel. Thicker coatings will last longer (within practical limits) but when the zinc reservoir is depleted, steel underneath will begin to corrode. ISO 1461 is widely used to specify galvanized coatings.

Galvanizing thickness can be increased by shot blasting, pickling (acid etching) and in some cases by double dipping. The coating thickness on bolts must be controlled to avoid clogging threads with zinc – this is done by spinning the item immediately after coating (called 'spin galvanizing').

Commonly specified coating thicknesses are:

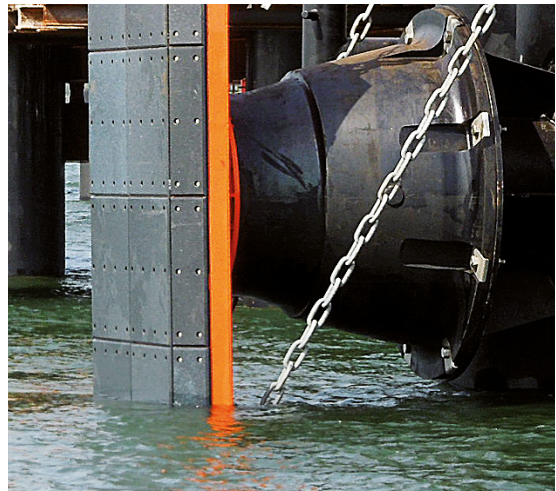

Standard shackle pins are zinc plated and not hot dip or spin galvanized.

Component	Nominal (Average)	Minimum (ISO 1461)
Hot dip galvanized fabrications ($t \geq 6$ mm)	85 μm (610 g/m ²)	70 μm (505 g/m ²)
Spin galvanized bolts (Dia ≥ 6 mm)	50 μm (360 g/m ²)	40 μm (285 g/m ²)

SACRIFICIAL ANODES

Sacrificial anodes work in a similar way to galvanizing but provide a larger zinc reservoir so they can protect steel and chains for longer. It is important that the anode is permanently immersed to avoid build up of an oxide surface layer which prevents the anode from working. Typical anodes for fenders will be approximately 4 kg and should be replaced every 2–5 years for best protection.



Anode weight is selected according to the protected area and lifetime. Please consult ShibataFenderTeam.

PAINT COATINGS

ISO 12944 is widely adopted as the international standard for paint coatings used on fender panels. This code is divided into environmental zones and durability classes. For longest service life in seawater, splash zone and inter-tidal locations, the C5M(H) class is recommended with typical service life expectancy of at least 15 years assuming proper inspection and preventative maintenance is carried out.

Paint	Surface	Base Coat(s)				Base Coat(s)			Total DFT	Service Life YEARS
		ISO 8501	BASE	TYPE	COATS	DFT	BASE	COATS		
Generic	SA2.5	Epoxy/PUR	Zinc rich	1	40 µm	Epoxy/PUR	3–4	280 µm	320 µm	> 15y
Jotun	SA2.5	Jotacoat	Epoxy	2	140 µm	TDS Hardtop PU	1	45 µm	325 µm	> 15y

STAINLESS STEEL

In highly corrosive locations it is recommended to use stainless steel fixings and bolts. Not all grades of stainless steel are suitable for marine use, but the widely known grades are:

SS 316/316L Grade	Austenitic stainless steel which is suitable for most fender applications. Also available as 316S33 with a higher Molybdenum content for greater durability.
Duplex / Super Duplex	Duplex and Super Duplex stainless steels are used where extra long service life is required and where access for maintenance may be difficult.
SS 304 Grade	This grade is not recommended for marine use and suffers from pitting (crevice) corrosion when attacked by salt.



Cold Welding (Galling)

Cold welding (also known as “galling”) is a phenomenon that can affect stainless steel fasteners. As the bolt is tightened, friction on the threads creates high local temperatures which welds the threads together, making it impossible to tighten or undo the fastener. It is recommended that a suitable anti-galling compound is applied to threads before assembly.

Durability of stainless steel for marine use is defined by its ‘Pitting Resistance Equivalent Number’ or PREN. A higher PREN indicates greater resistance, but usually at a cost premium.

Common Name	EN10088	Type	Cr (%)	Mo (%)	N (%)	PREN
	ASTM					Cr+3.3Mo+16N
Zeron 100	1.4501	Super Duplex	24.0–26.0	3.0–4.0	0.20–0.30	37.1–44.0
	S32760		24.0–26.0	3.0–4.0	0.30–0.30	37.1–44.0
Duplex	1.4462	Duplex	21.0–23.0	2.5–3.5	0.10–0.22	30.9–38.1
	S31803		21.0–23.0	2.5–3.5	0.08–0.20	30.5–37.8
316/316L	1.4401	Austenitic	16.5–18.5	≤ 2.00	≤ 0.11	24.9–26.9
	316/316L		16.0–18.0	≤ 2.00	≤ 0.10	24.2–26.2

TESTING PROCEDURE

ShibataFenderTeam's standard testing procedure for 'engineered'¹ solid rubber fenders complies with PIANC 'Guidelines for the Design of Fender Systems: 2002: Appendix A: Section 6: Verification/Quality Assurance Testing'.

TEST EQUIPMENT AND MEASURING DEVICES

The test equipment is fully fitted with calibrated load cells or pressure transducer and linear transducer(s) for measuring displacement to allow continuous monitoring of fender performance. All test equipment is calibrated and the calibration certificates are revalidated frequently to be within their validity period of one year at any time.

TEST PROCEDURE – METHOD CV

Testing of molded² fenders and wrapped cylindrical³ fenders is carried out in-house, with the option of third-party witnessing, using full size fenders in accordance with the following test setup which follows PIANC guidelines (Appendix A:4.1):

- ▶ All fender units have a unique serial number which can be traced back to manufacturing and testing records.
- ▶ Fenders are tested under direct (vertical) compression.
- ▶ The fender shall be compressed 3 times up to its rated deflection following a recovery period of at least one hour.
- ▶ Test temperature is $23^{\circ}\text{C} \pm 5^{\circ}\text{C}$ ⁴.
- ▶ Actual performance values are recorded from 4th compression.
- ▶ Compression speed is 2 – 8 cm/min.
- ▶ During the test, the load shall be recorded to a precision of $\pm 1.0 \text{ kN}$ ($\pm 0.1 \text{ t}$) and the deflection to $\pm 0.5 \text{ mm}$, unless otherwise specified.
- ▶ Energy absorption⁵ is determined as the integral of reaction and deflection, calculated using Simpson's Rule.
- ▶ Compression shall be stopped once 110% of rated reaction force, maximum specified reaction force or, nominal / max. fender deflection has been reached.
- ▶ If any sample does not satisfy the specifications, sampling of the remainder is increased to 20% of fenders (rounded up to a unit), excluding non-compliant units.
- ▶ If any further sample does not satisfy the specifications, 100% of remaining samples will be tested. Only units which satisfy the specifications shall be passed for shipment. The non-compliant fenders will be rejected.

¹ As defined in PIANC Appendix A: Section 1.2, small fendering bumpers are excluded.

² Molded Fenders include SPC, CSS, FE, SX, SX-P and SH Fenders. SPC, CSS, SX, SX-P and SH Fenders are tested singly, FE Fenders are tested in pairs.

³ Excluding Tug Cylindrical Fenders.

⁴ Where ambient temperature is outside of this range, fenders shall be normalized to this temperature range in a conditioning room for an appropriate period (dependent upon fender size) or performance values may be corrected according to temperature correction factor tables at the sole discretion of the supplier. Stabilization time shall be not less than $20x^{1.5}$ days, rounded to the next whole day (x = dimension of greatest rubber thickness, in meters).

⁵ Reaction force (and corresponding calculated energy absorption) is corrected for initial berthing speed and temperature where applicable.



Rubber Fender Testing

PASS CRITERIA

Verification testing (or quality control testing) is carried out to prove the performance of fenders in accordance with catalogue RPD or other customer-specified values. Samples from the actual fenders for the project are tested. Results obtained are adjusted if necessary using the correction factor tables for initial impact speed and temperature. The fender passes verification testing if it meets the following conditions:

1. Visual

There is no visual evidence of defects, such as bonding failures or splits on the surface of the fender.

2. Performance

The fender provides Required Performance (Required Energy and Reaction) within production tolerances, if it meets the following requirements simultaneously at any point during the test.*

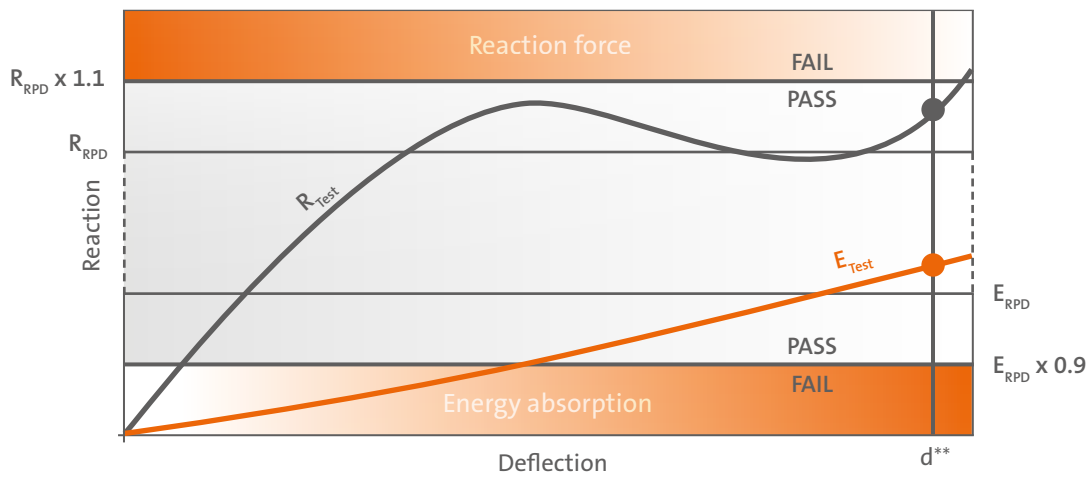

REACTION FORCE PASS CRITERIA

R_{Test} Velocity-and-temperature-adjusted reaction is less than or equal to required reaction multiplied by the nominal reaction tolerance* (high end) specified in the catalogue.

$$R_{Test} \leq R_{RPD} \times 1.1$$

ENERGY ABSORPTION PASS CRITERIA

E_{Test} Velocity-and-temperature-adjusted energy absorbed is greater than or equal to required energy multiplied by the nominal energy tolerance* (low end) specified in the catalogue.

$$E_{Test} \geq E_{RPD} \times 0.9$$

R_{Test} = Velocity-and-temperature-adjusted reaction force from verification testing

R_{RPD} = RPD Performance Data, Reaction

E_{Test} = Velocity-and-temperature-adjusted energy absorption from verification testing

E_{RPD} = RPD Performance Data, Energy

* Standard manufacturing tolerances, see ShibataFenderTeam product catalogue p. 124

** Deflection is not a pass/fail criteria, please refer to PIANC2002 page 49 point 6.1.2

NOTES

- ▶ Standard PIANC Verification Testing is considered on 10% of the fenders of one size and grade, produced in the same mold for the respective order (rounded up to a full unit).
- ▶ A single break-in deflection is mandatory for fenders with a reaction force of 100 t or more, which are to be installed on load sensitive structures (see PIANC 6.2.1).
- ▶ All measuring equipment shall be calibrated and certified, to be accurate within $\pm 1\%$ according to ISO, equivalent JIS or ASTM requirements. Calibration shall be traceable to national / international standards and shall be performed annually by an accredited third-party organization.
- ▶ Standard PIANC testing is included in the fender price. Other testing frequency, third-party witnessing and temperature conditioning costs are to be borne by the purchaser.

FE ANALYSIS

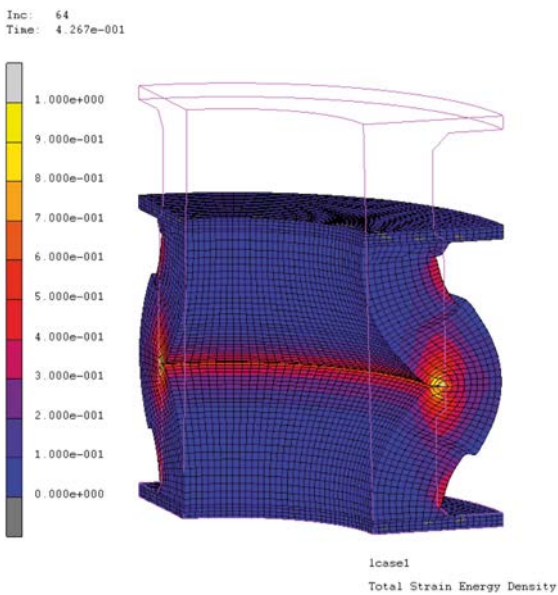

SPC Fender angular compression testing with restrain chains



Climate Chamber



CSS Fender shear testing with panel and UHMW-PE face pads

QUALITY CERTIFICATES



- ▶ ISO 14001:2015 – Certified production facility (Shibata Industrial Co. Ltd.)
- ▶ ISO 9001:2015 – Certified supply chain (Shibata Industrial Co. Ltd.)
- ▶ ISO 9001:2008 – Certified supply chain (ShibataFenderTeam AG)
- ▶ EN 1090-2:2008+A1:2011 – EXC3 Certified workshops (ShibataFenderTeam AG)

TYPE EXAMINATION CERTIFICATE	TYPE EXAMINATION CERTIFICATE	TYPE EXAMINATION CERTIFICATE	TYPE EXAMINATION CERTIFICATE	TYPE EXAMINATION CERTIFICATE	TYPE EXAMINATION CERTIFICATE	TYPE EXAMINATION CERTIFICATE
<p>This is to certify: That the Fender with type designation(s) SPC Cone Fender Issued to ShibataFenderTeam AG Hamburg, Germany</p> <p>is found to comply with Guidelines for the Design of Fender Systems</p> <p>Application : Moulded rubber fender for marine applica</p> <p>Issued at Hamburg on 2018-09-03</p> <p>This Certificate is valid until 2023-07-31. DNV GL local station: Hamburg</p> <p>Approval Engineer: Joachim Rehhahn</p>	<p>This is to certify: That the Fender with type designation(s) CSS Cell Fender Issued to ShibataFenderTeam AG Hamburg, Germany</p> <p>is found to comply with Guidelines for the Design of Fender Systems</p> <p>Application : Moulded rubber fender for marine applica</p> <p>Issued at Hamburg on 2018-09-03</p> <p>This Certificate is valid until 2023-07-31. DNV GL local station: Hamburg</p> <p>Approval Engineer: Joachim Rehhahn</p>	<p>This is to certify: That the Fender with type designation(s) FE Element Fender Issued to ShibataFenderTeam AG Hamburg, Germany</p> <p>is found to comply with Guidelines for the Design of Fender Systems</p> <p>Application : Moulded rubber fender for marine applica</p> <p>Issued at Hamburg on 2018-09-06</p> <p>This Certificate is valid until 2022-10-31. DNV GL local station: Hamburg</p> <p>Approval Engineer: Joachim Rehhahn</p>	<p>This is to certify: That the Fender with type designation(s) Cylindrical Fender Issued to ShibataFenderTeam AG Hamburg, Germany</p> <p>is found to comply with Guidelines for the Design of Fender Systems</p> <p>Application : Moulded rubber fender for marine applica</p> <p>Issued at Hamburg on 2018-09-06</p> <p>This Certificate is valid until 2022-10-31. DNV GL local station: Hamburg</p> <p>Approval Engineer: Joachim Rehhahn</p>	<p>This is to certify: That the Fender with type designation(s) V Fender (Type SK, SK-P, SH) Issued to ShibataFenderTeam AG Hamburg, Germany</p> <p>is found to comply with Guidelines for the Design of Fender Systems</p> <p>Application : Moulded rubber fender for marine applica</p> <p>Issued at Hamburg on 2018-09-06</p> <p>This Certificate is valid until 2022-10-31. DNV GL local station: Hamburg</p> <p>Approval Engineer: Joachim Rehhahn</p>	<p>This is to certify: That the Fender with type designation(s) Ocean Guard Issued to ShibataFenderTeam AG Hamburg, Germany</p> <p>is found to comply with Guidelines for the Design of Fender Systems</p> <p>Application : Foam filled floating fender for marine app</p> <p>Issued at Hamburg on 2018-09-05</p> <p>This Certificate is valid until 2022-10-31. DNV GL local station: Hamburg</p> <p>Approval Engineer: Joachim Rehhahn</p>	<p>This is to certify: That the Fender with type designation(s) Donut Fender Issued to ShibataFenderTeam AG Hamburg, Germany</p> <p>is found to comply with Guidelines for the Design of Fender Systems : 2002 (PIANC 2002)</p> <p>Application : Foam filled floating fender for marine application</p> <p>Issued at Hamburg on 2018-03-06</p> <p>This Certificate is valid until 2023-03-05. DNV GL local station: Hamburg</p> <p>Approval Engineer: Joachim Rehhahn</p> <p>Thorsten Lohmann Head of Section</p>

Type approval certificates according to PIANC 2002. For verification, please check: <https://approvalfinder.dnvgl.com>

- ▶ SPC Cone Fenders
- ▶ CSS Cell Fenders
- ▶ FE Element Fenders
- ▶ Cylindrical Fenders
- ▶ V Fenders
- ▶ Ocean Guard Fenders
- ▶ Donut Fenders

PROJECT REQUIREMENTS

Port:
 Berth:
 Client:
 Designer:
 Contractor:

Accurate project information is needed to propose the most suitable fenders.

Please use the table below to describe the operating requirements with as much detail as possible.

Project: New Construction Upgrade

Status: Preliminary Detail Tender

SHIP INFORMATION

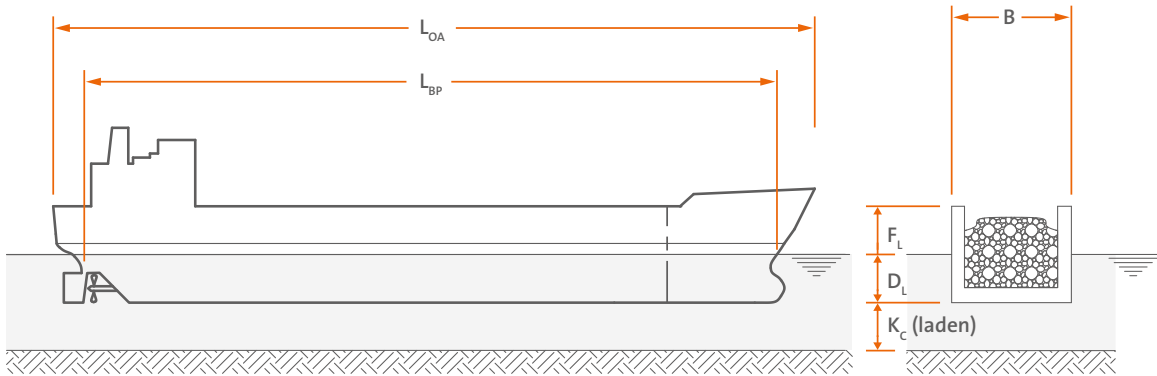

LARGEST SHIPS

Type/Class
 Deadweight DWT
 Displacement t
 Length Overall m
 Beam m
 Draft m
 Hull Pressure kN/m² (kPa)
 Belting Yes No Size
 Bow Flare deg.
 Bow Radius m

SMALLEST SHIPS

Type/Class
 Deadweight DWT
 Displacement t
 Length Overall m
 Beam m
 Draft m
 Hull Pressure kN/m² (kPa)
 Belting Yes No Size
 Bow Flare deg.
 Bow Radius m

BERTH INFORMATION

CLOSED BERTH FACE

PART-CLOSED BERTH FACE

OPEN STRUCTURE

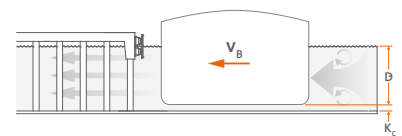
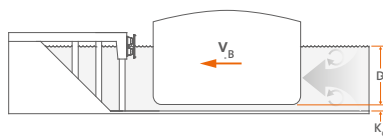
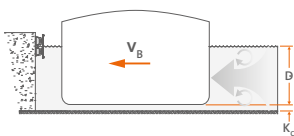

Berth Type Continuous Wharf Dolphins Pontoon Lock or Drydock Other

Length of Berth m
 Fender Spacing m
 Deck Level m (above datum)
 Highest Tide (HHW) m (above datum)
 Under Keel m (min) m (max)
 Import/Export Import Export Both

Maximum Reaction kN
 Soffit Level m (above datum)
 Lowest Tide (LLW) m (above datum)
 Wind Speed m/s
 Current Speed m/s

LOCATION

- Climate** Moderate Tropical Desert Mediterranean Polar
Temperature °C (min) °C (max) **Corrosivity** High Medium Low
Water type Sea Fresh SG = t/m³ **Winter Ice** Never Sometimes Every Year

BERTHING INFORMATION

- Point of contact Midships Thirdpoint Quarterpoint Fifthpoint Sixthpoint

Side Berthing

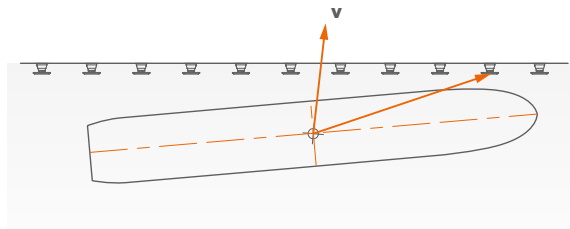

Approach Speed m/s
 Berthing Angle deg.
 Factor of Safety

End Berthing

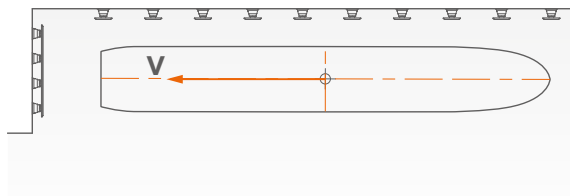

Approach Speed m/s
 Berthing Angle deg.
 Factor of Safety

Dolphin Berthing

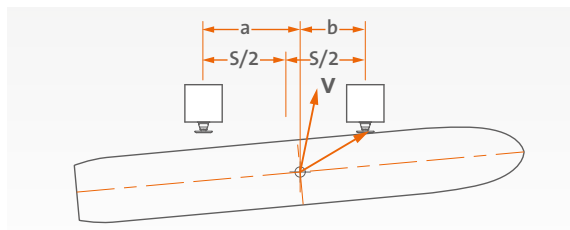

Approach Speed m/s
 Berthing Angle deg.
 Factor of Safety

Lock Entrance

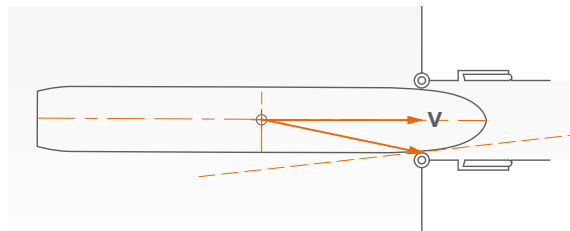

Approach Speed m/s
 Berthing Angle deg.
 Factor of Safety

Lithering (Ship-to-Ship)

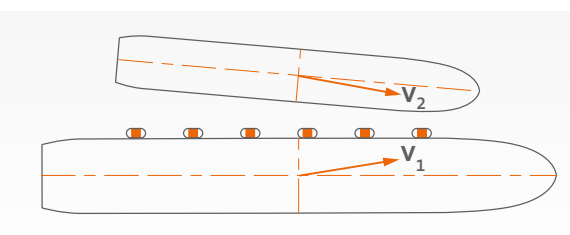

Approach Speed m/s
 Berthing Angle deg.
 Factor of Safety

OTHER INFORMATION

- Design Code:**
- PIANC
 - BS6349
 - EAU-2004
 - ROM 0.2-90
 - ROSA 2000
 - ASNZ 4997
 - UFC 4-152-01
 - Other

CONVERSION FACTORS

ANGLE	degrees	minutes	seconds	Radian
1 RADIAN	57.3	3,438	2.063×10^5	1
1 degree	1	60	3,600	1.745×10^{-2}
DISTANCE	m	in	ft	Nautical Mile
1 METER	1	39.37	3.281	5.4×10^{-4}
1 inch	2.54×10^{-2}	1	8.333×10^{-2}	1.371×10^{-5}
1 foot	0.3048	12	1	1.646×10^{-4}
1 nautical mile	1,852	$7,291 \times 10$	6,076.1	1
AREA	m²	cm²	in²	ft²
1 SQUARE METER	1	10^4	1,550	10.76
1 square centimeter	10^{-4}	1	0.155	1.076×10^{-3}
1 square inch	6.452×10^{-4}	6.452	1	6.944×10^{-3}
1 square foot	9.290×10^{-2}	929	144	1
VOLUME	m³	cm³	litres	ft³
1 CUBIC METER	1	10^6	1,000	35.31
1 cubic centimeter	10^{-6}	1	10^{-3}	3.531×10^{-8}
1 litre	10^{-3}	1,000	1	3.531×10^{-2}
1 cubic foot	2.832×10^{-2}	2.832×10^4	28.32	1
MASS	kg	t	lb	
1 KILOGRAM	1	10^{-3}	2.205	
1 tonne	10^3	1	2,205	
1 pound	0.454	4.536×10^{-4}	1	
DENSITY	kg/m³	t/m³	lb/ft³	lb/in³
1 KILOGRAM/METER ³	1	10^{-3}	6.243×10^{-2}	3.613×10^{-5}
1 tonne/meter ³	10^3	1	62.428	3.613×10^{-2}
1 pound/foot ³	16.018	1.602×10^{-2}	1	5.787×10^{-4}
1 pound/inch ³	27,680	27.68	1,728	1
VELOCITY	m/s	mph	kph	kt
1 METER/SECOND	1	2.237	3.600	1.944
1 mile per hour	0.447	1	1.609	0.869
1 kilometer per hour	0.278	0.621	1	0.54
1 knot	0.514	1.151	1.852	1
FORCE	kN	tf	lbf	kip
1 KILONEWTON	1	0.102	224.8	0.225
1 tonne force	9.807	1	2,204	2.205
1 kip	4.448	0.454	10^3	1
ENERGY	kNm (kJ)	tm	kip-ft	
1 KILONEWTON METER	1	0.102	0.738	
1 tonne-meter	9.807	1	7.233	
1 kip-foot	1.356	0.138	1	
PRESSURE, STRESS	kN/m² (kPa)	N/mm² (MPa)	tf/m²	lbf/in² (psi)
1 NEWTON/METER ²	0.001	10^{-6}	1.02×10^{-4}	1.450×10^{-4}
1 kilopascal	1	10^{-3}	0.102	0.145
1 megapascal	10^3	1	102	145
1 tonne force/meter ²	9.807	9.807×10^{-3}	1	1.422
1 pound force/inch ² (psi)	6.895	6.895×10^{-3}	0.703	1
GRAVITY	m/s²	cm/s²	in/s²	ft/s²
1 g	9.807	980.7	386.1	32.174

AFTER SALES & WARRANTY

ShibataFenderTeam is committed to providing support and assistance during commissioning and long into the future. With our own installation and maintenance team based in Germany, we can offer assistance during the installation and/or maintenance works. We support customers with routine overhauls and upgrades, or to recover quickly in the event of accidental damages. Standard and extended warranties are available, as well as guidance on inspection and maintenance regimes to ensure our fender systems always provide the best performance and protection.

The standard warranty period is 12 months from installation or 18 months from shipping date, what ever comes first. Extended warranty periods or warranty extensions, for example for corrosion protection, can be agreed upon in special cases upon request. In all cases ShibataFenderTeam warranties are subject to berth operators conducting periodic inspections according to our recommendations, as well as timely submission of reports and photographs. This allows any issues arising to be detected early, then rectified and monitored.

Warranties do not cover accidental damage, normal wear and tear, visual appearance or the effects of environmental degradation over time. In the unlikely event of a claim for faulty materials and/or workmanship, ShibataFenderTeam will repair or replace the defective components at its discretion. Compensation values cannot exceed the cost of supplied materials, less any reduction for normal use, and in no circumstances are costs of removal or reinstallation, or any consequential costs, losses or liabilities accepted.

ShibataFenderTeam recommends that users adopt an asset management system based on ISO 55000 (or PAS-55).

DISCLAIMER

These instructions have been prepared with the greatest possible care and to the best of our knowledge and belief. All technical specifications, product descriptions and planning principles used are correct at the time of going to press. ShibataFenderTeam AG, its subsidiaries, agents and associates do not accept the responsibility or liability for any errors and omissions for whatsoever reason. When using this technical manual to develop a design, customers are strongly recommended to request a detailed specification, calculations and certified drawings from our specialists prior to construction and/or manufacture. ShibataFenderTeam constantly strives to improve the quality and performance of products and systems. We reserve the right to change specification without prior notice. All dimensions, material properties and performance values quoted are subject to normal production tolerances. This manual supersedes the information provided in all previous editions. It should always be used in conjunction with our current product catalogue. If in doubt, please consult ShibataFenderTeam.

FLAG

© 2026 ShibataFenderTeam AG, Germany

This catalogue is the copyright of ShibataFenderTeam AG and may not be reproduced, copied or distributed to third parties without the prior consent of ShibataFenderTeam in each case.

ShibataFenderTeam® is a Registered Trade Mark of ShibataFenderTeam AG.

Date: 05 / 2026, Layout: wn8.de





OUR OFFICES.



Presented by:

www.sft.group